



GYS

CAR BODY WELDING SYSTEMS 2024B

www.gys.fr

Celebrating

60

years of innovation

1964 - 2024



INVEST IN THE FUTURE



French manufacturer since 1964

Collision Repair

Solutions Réparation Carrosserie

Karosseriereparatur

Attrezzature Riparazione Carrozzerie

Reparación de Carrocería

2024B



SPOT WELDING - DENT PULLER - MIG-MAG/GMAW-FCAW - PLASMA CUTTING -
INDUCTION - RIVETING - LIFT - BODYSHOP TOOLS

INVEST IN THE FUTURE

A solid manufacturing group

900 people € 130 000 000

C1+ Credit Rating Banque de France
55 000 m² 2 factories



INVEST IN THE FUTURE



French manufacturer since 1964

A family company



Nicolas & Bruno Bouygues



Welding, Plasma cutting & Induction heating



Collision repair



Chargers, Boosters & Starters

A worldwide coverage

125 countries



GYS FRANCE Laval

GYS GERMANY Aachen

GYS U.K. Rugby

GYS CHINA Shanghai

GYS ITALIA Venezia

GYS IBERICA Madrid

www.gys.fr



visit with



DENT PULLING

GYS POT	6
GYS POT PRO	7
GYS POT ALU	8
GYS POT COMBI	9
ACCESSORIES & CONSUMABLES	10
GYS POT ARCPULL	12
COMBI ARCPULL	13
ACCESSORIES & CONSUMABLES	16
FAST EASY TOOLS	18
ACCESSORIES LEVELLING BARS	20
COMPLETE WORKSTATIONS	24

PULLING SYSTEMS

AIRFIX DRAW ALIGNER	38
DRAW ALIGNER	40
FRAME STRAIGHTENING	42

PAINTLESS DENT REPAIR

POWERDUCTION AUTO DENT REPAIR	46
GLUE PULLING REPAIR	50

SPOT WELDING

TECHNOLOGY	54
PORTASPOT / GYS POT 32D-X / 100R-CX	56
GYS POT BP GENIUS	58
GYS POT PTI-S7 / PTI PREMIUM PRO	60
GYS POT PTI GENIUS	62
GYS POT PTI NEO	64
GYS POT PTI MASTER / PTI EXPERT	66
G ARMS	68
ACCESSORIES & CONSUMABLES	69
X ARMS / C ARMS	70

RIVETING

GYS PRESS 10T	73
GYS PRESS PREMIUM 10T PP	75
WORKSTATION	76
ADAPTERS	78
DIES BOXES & RIVETS	80
ACCESSORIES	83

MIG WELDING

GYS AUTO	86
E GYS AUTO	88
P GYS AUTO	90
AUTOPULSE	92
TORCHES & CONSUMABLES	96

PLASMA

EASYCUT K	101
EASYCUT	102
CUTTER	103

INDUCTION HEATING

GYS DUCTION	106
COMBI DUCTION	107
POWER DUCTION	108
ACCESSORIES & CONSUMABLES	112

TRUCK TOOLS & MOBILE LIFTS

TROLLEY IW1	115
MULTITOOL TRUCK	115
SPOT LIFT	116
QUICKLIFT / AIR JACKS	118
ERGO LIFT	119
MANUAL DOOR LIFT / MANUAL WHEEL LIFT	120

ACCESSORIES

WELDING HELMETS	122
FUME EXTRACTION	125
WINDSCREEN REPAIR	123
BUMPER REPAIR	128
HAND TOOLS	130
PNEUMATIC TOOLS	134
WORKING LIGHTS	136
SANDING & DUST EXTRACTION	138
WORKING SUPPORTS	140
ELECTRIC VEHICLES	144
SAFETY PROTECTION	146



DENT PULLING

STEEL / ACIER / STAHL

GYSPOT	6
GYSPOT PRO	7

ALU

GYSPOT ALU	8
------------	---

ALU + STEEL / ACIER / STAHL

GYSPOT COMBI	9
ACCESSORIES & CONSUMABLES	10

DRAWN ARC ALU + STEEL / ACIER / STAHL

GYSPOT ARCPULL	12
COMBI ARCPULL	13
ACCESSORIES & CONSUMABLES	16

FAST DENT PULLING	18
-------------------	----

LEVELLING BARS	20
----------------	----

COMPLETE WORKSTATIONS	24
-----------------------	----



GYSPOT

DENT PULLING STEEL ACIER - STAHL

- Stars - Étoiles - Ausbeulstern
- Rings - Anneaux - Zugösen
- Wavy wires - Fils ondulés - Wellendraht
- Impact shrinking - Rabattage d'impact - Glätten

OPTIONS

Consommables - Consumables p.10



Chariots - Trolleys p.24



- Stars - Étoiles - Ausbeulstern
- Rings - Anneaux - Zugösen
- Wavy wires - Fils ondulés - Wellendraht
- Impact shrinking - Rabattage d'impact - Glätten
- Tempering - Rétreinte - Temperieren



FIXED GUN

FIXED GUN

GYSPOT 26.02

2600 A x1 **AUTOMATIC**

230V • 1~

052208

included

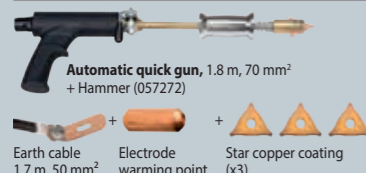

Earth cable 1.7 m, 50 mm² Electrode warming point Star copper coating (x3)

GYSPOT 27.02

2600 A x1 **MANUAL**

230V • 1~

055353

included

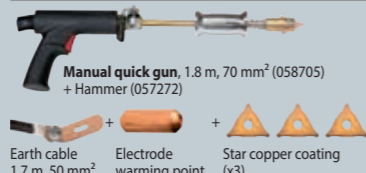

Earth cable 1.7 m, 50 mm² Electrode warming point Star copper coating (x3)

GYSPOT 34.02 & 34.04

3500 A x1 **MANUAL**

230V • 1~

GYSPOT 34.02
065741

400V • 2~

GYSPOT 34.04
067943

included

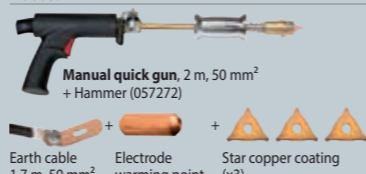

Earth cable 1.7 m, 50 mm² Electrode warming point Star copper coating (x3)

- Stars - Étoiles - Ausbeulstern
- Rings - Anneaux - Zugösen
- Wavy wires - Fils ondulés - Wellendraht
- Impact shrinking - Rabattage d'impact - Glätten
- Tempering - Rétreinte - Temperieren
- Rivets - Rivets - Nieten
- Rings - Rondelles - Unterlegscheiben
- Studs - Goujons - Gewindebolzen

SYNERGIC CONTROL

PATENTS REGISTERED NUMBERS EUROPEAN TRADEMARK & DESIGN



GUN WITH CONNECTOR

GYSPOT 39.02 & 39.04

3800 A x1 **AUTOMATIC**

230V • 1~

GYSPOT 39.02
052215

400V • 2~

GYSPOT 39.04
052222

included

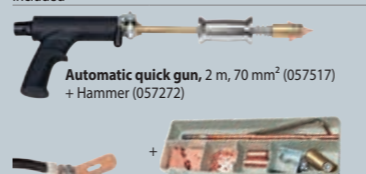

Earth cable 2 m, 70 mm² SPOTTER BOX STANDARD (053915) (Details p.10)

GYSPOT PRO 230 & PRO 400

3800 A x2 **AUTOMATIC**

230V • 1~

GYSPOT PRO 230
052178

400V • 2~

GYSPOT PRO 400
052185

included

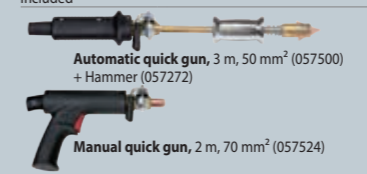

Earth cable 2 m, 70 mm² SPOTTER BOX PRO (050075) (Details p.10)

GYSPOT EXPERT 200, 230 & 400

3800-4500 A x2 **AUTOMATIC**

230V • 1~

GYSPOT EXPERT 230
066885

200-240V • 1~

GYSPOT EXPERT 200
058842

4350 > 5100 A

GYSPOT EXPERT 400
058859

included

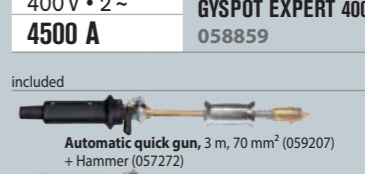

Earth cable Thick 3 mm 2 m, 70 mm² SPOTTER BOX PRO (050075) (Details p.10)

QUICK GUNS

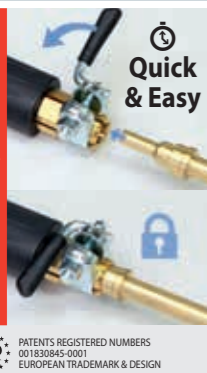

Quick & Easy

AUTOMATIC



WITH CONNECTOR
2 m, Ø 70 mm²
included 39.02/04
057517



WITH CONNECTOR
3 m, Ø 50 mm²
included PRO 230/400
057500

WITH CONNECTOR
3 m, Ø 70 mm²
included EXPERT 200/230/400
059207

MANUAL



WITH CONNECTOR
cable 2 m, Ø 70 mm²
included PRO 230/400,
EXPERT 200/230/400,
COMBI 230EPRO
057524

No connector
cable 1.8 m, Ø 70 mm²
for 27.02
058705

No connector
cable 2 m, Ø 50 mm²
for 34.02/34.04

Mandrels for gun - Mandrins pour pistolets - Pistole & Anschlußstücke, Zubehör



QUICK GUN
057531



D1
048959



Nut - Écrou
053199

Microswitch
053267

MADE IN GYS CHINA	GYS NORM 62135	50/60 Hz	I ₂ max	U ₂	I _{LAM}	I _{RMS}	kW	OK	OK	MANUAL	SYNERGIC	Wavy wires	Stars	RINGS	AUTOMATIC	MANUAL	SEPARATE CABLE GUN	LxWxH cm / kg
MADE IN GYS CHINA	GYSPOT 26.02	230V	2 m	2600	5,4	16	1800	10	OK	—	—	—	—	—	—	—	—	40 x 25 x 31 / 18
	GYSPOT 27.02	230V	2 m	2600	5,4	16	1800	10	OK	—	—	—	—	—	—	—	—	40 x 25 x 31 / 18
	GYSPOT 34.02	230V	2 m	3500	7,4	16	2500	20	OK	OK	—	—	—	—	—	—	—	42 x 36 x 31 / 23.9
	GYSPOT 34.04	400V, 2ph	4 m	3500	7,4	16	2500	20	OK	OK	—	—	—	—	—	—	—	42 x 36 x 31 / 24
MADE IN FRANCE	GYSPOT 39.02	230V	4 m	3800	7,4	16	2800	20	OK	OK	—	—	—	—	—	—	—	49 x 38 x 29 / 27.5
	GYSPOT 39.04	400V, 2ph	4 m	3800	7,4	16	2800	20	OK	OK	—	—	—	—	—	—	—	49 x 38 x 29 / 25.2
	GYSPOT PRO 230	230V	8 m	3800	7,4	16	2800	20	OK	OK	—	—	—	—	—	—	—	49 x 38 x 29 / 29.6
	GYSPOT PRO 400	400V, 2ph	8 m	3800	7,4	16	2800	20	OK	OK	—	—	—	—	—	—	—	49 x 38 x 29 / 29.4
	GYSPOT EXPERT 200	200-240V	8 m	4350 > 5100	7,2-8,7	30(D)	3100 > 3600	25 > 36	OK	OK	—	—	—	—	—	—	—	49 x 38 x 29 / 34.6
	GYSPOT EXPERT 230	230V	8 m	3800	7,4	16	2800	20	OK	OK	—	—	—	—	—	—	—	49 x 37 x 31 / 30.6
	GYSPOT EXPERT 400	400V, 2ph	8 m	4500	7,4	16(D)	3200	25	OK	OK	—	—	—	—	—	—	—	49 x 38 x 29 / 32.9

GYSPOT

STEEL DENT PULLING



GYS POT ALU

DENT PULLING ALU



SYNERGIC CONTROL

PATENTS REGISTERED NUMBERS EUROPEAN TRADEMARK & DESIGN



Goujons - Studs

NEW



FIXED GUN

GYS POT ALU 66

13000 A x1 AUTOMATIC

230V • 1~ AD

080188

included for $\varnothing 4$ mm



AD ANTI-DUST



GYS POT ALU PRO FV

13000 A x1 AUTOMATIC

110 > 230V • 1~ FV

021990

included for $\varnothing 4$ mm



FV FLEXIBLE VOLTAGE

85 V ← 265 V

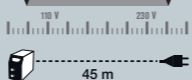

ALU GUN

AUTOMATIC

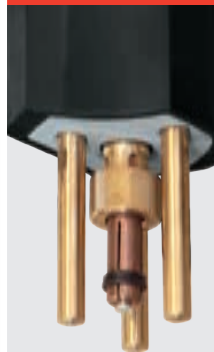

3 m, $\varnothing 25$ mm²

included SPOT ALU FV & COMBISLOT 230

054066

(x 3) 065635

66 mF CAPACITOR DISCHARGE WELDING

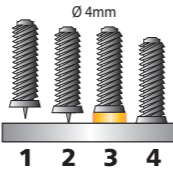

Joint rings for mandrel $\varnothing 4/5/6$ x 2 060814

OPTIONS

Consumables - Consommables p.11



ALU accessories - Accessoires ALU p.19



Trolleys - Chariots p.24



GYS POT COMBI

DENT PULLING ALU+STEEL ACIER - STAHL

PATENTS REGISTERED NUMBERS EUROPEAN TRADEMARK & DESIGN

Steel / Acier / Stahl

Alu



- Stars - Étoiles
- Rings - Anneaux
- Wavy wires - Fils ondulés
- Impact shrinking - Rabattage d'impact
- Tempering - Rétreinte
- Rivets - Rivets
- Rings - Rondelles
- Studs - Goujons

2 GUNS INCLUDED



GUN WITH CONNECTOR

GYS POT COMBI 230 E.PRO

3800 A Acier / Steel / Stahl

13000 A Alu

230V • 1~

x2 AUTOMATIC MANUAL AUTOMATIC

021266

included

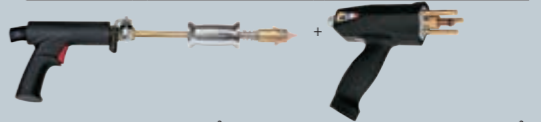

Manual quick gun, 2 m, 70 mm² (057524) + Hammer (057272)

Automatic alu gun, 3 m, 25 mm²



Earth cable 2 m, 70 mm²

SPOTTER BOX PRO (050075) (Details p.10)

ALU BOX STANDARD (050020) (Details p.11)

PATENTS REGISTERED NUMBERS EUROPEAN TRADEMARK & DESIGN

	CE	50/60 Hz	I ₂ max	U ₂	I _{RMS}	kW	MANUAL	SYNERGIC	AUTOMATIC	MANUAL	SEPARATE CABLE GUN	MANUAL	SEPARATE CABLE GUN	LxWxH cm / kg				
MADE IN GYS CHINA	62135	230V	6 m	13 000	50 > 200	5	—	0.52	OK	OK	■	■	—	3 m	Included Alu box	27 x 20.5 x 27 / 13.5		
MADE IN FRANCE	GYS POT ALU PRO FV	110 > 230V	6 m	13 000	50 > 200	5	—	0.65	OK	OK	■	■	—	3 m	Included Alu box	49 x 38 x 29 / 13.4		
		230V	8 m	3800 (steel) 13000 (alu)	7,4 (steel) 50 > 200 (alu)	16	2800 (steel)	20	OK	OK	—	■	■	■	x1	x1	■	2/3 m

ALU + STEEL DENT PULLING



STEEL / ACIER / STAHL



DENT BOX
CONSUMABLES / BAR / EASY



SPOTTER BOX
STANDARD / 2600 / 2700



SPOTTER BOX
PRO

hexagon	Earth plate small
---------	-------------------

▼ Star - Étoile - Ausbeulstern		○ Ring - Rondelle - Unterlegscheiben		∟ Tempering - Rétreinte - Temperieren		↙ Impact shrinking & Lock nut - Rabattage d'impact & Écrou - Glätten		〰 Wavy wire - Fil ondulé - Wellendraht			
chuck for inertia hammer	copper coating star	electrode ø 16 for 8 x 16	ø 8 x 16	earth hook	carbon heating electrode	electrode warming point ø 16	Ball electrode warming point ø 16	M8	electrode	wavy wire	magnetic positioner
x1	x20	x1	x100	x1	x5	x1	x1	x100	x1	x50	x1
049482	052239	049574	049444	056718	049468	049567	059726	050303	049789	049727	049772

♀ Rings - Anneaux - Zugösen				♂ Studs - Goujons - Gewindebolzen				T Rivets - Rivets - Nieten			I Nails - Clous		Stitch welding - Molette				
elec-trode	straight rings	twisted rings	lifting rod	electrode for threaded studs rivets ø 5 - M5, M6	threaded M5 x 18 x 0.8	self-threading ø 5 x 18	ø 5 x 12	electrode ø 16, 3 x 4,50	ø 3 x 3.25	ø 3 x 4.50	electrode ø 2 - M4	ø 2	electrode wheel ø 16	flat n°27	Earth plate large	magnetic	Steel gun earth adapter Ø 25 mm²
x1	x100	x50	x3 180, 300, 500 mm	x1	x100	x100	x100	x1	x100	x100	x1	x100	x1	x1	x1	x1	x1
050655	050648	050631	050792	049598	049383	049420	049413	049604	049345	049352	049277	041561	050310	049673	052529	049666	051997

DENT BOX

CONSUMABLES 051515	x20
BAR 050037	ideal PROLINER
EASY 053632	included EASYLINER

SPOTTER BOX

PRO 050075	included PRO, EXPERT & COMBI 230
STANDARD 053915	
2600 052277	ideal GYSPOT 2600
2700 053922	ideal GYSPOT 2700

x1	x1	x1	x20	x1	x50	x1	x1	x1	x1	x1	x25	x1	x25	x1	x50	x25	x1	x180mm	x1	x180mm	x1	x50	x50	x50	x1	x100	x100
----	----	----	-----	----	-----	----	----	----	----	----	-----	----	-----	----	-----	-----	----	--------	----	--------	----	-----	-----	-----	----	------	------

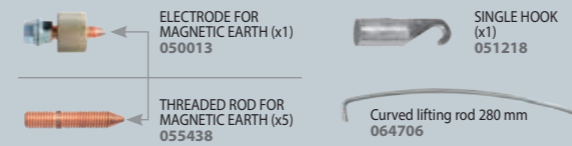

SLIDE HAMMERS - Marteaux inertie - Ausbeulhammer

COMPLETE
057272

1.1 kg

Options: (x1) 054028, (x5) 050839

included (x1) 049482, included (x20) 052239

COMPLETE KIT
051225

2.5 kg

(x1), (x25), (x1), (x1), (x50)



Nails - Clous - Nägel
041813

1.1 kg

Ø 2, M4 (x1) 049277, Ø 2 (x100) 041561, MIG/MAG nozzle for Nail welding 041523

Washers - Rondelles - Ringe
051201

1.7 kg

51 cm

Ø 16, 8x16 (x1) 049574, 8x16 (x100) 049444, (x1) 051218

Slide hammer kit - Kit marteau à inertie - Ausbeulhammerset
051928

6 kg

ALU



Joint rings for mandrel Ø 4/5/6 x2 060814

mandrel for ALU GUN		alu magnesium screws 12 mm			alu silicium screws 12 mm			screwable rings	fast pulling rings	lifting rod			
ø 4 x2	ø 5 x1	ø 6 x1	ø 4 - M4 x200	ø 4 - M4 x1000	ø 5 x100	ø 6 x100	ø 4 x5	ø 5 x5	x3 : 180, 300, 500 mm				
049000	048157	048164	050273	050129	048140	048133	050280	050136	048126	048003	050297	058712	050792

LIGHT Ø 4 051522	x200	x200	x200	x200	x200	x200	x200	x200	x200
STANDARD Ø 4 050020	x200	x200	x200	x200	x200	x200	x200	x200	x200
Ø 5 & 6 048195	x1	x1	x1	x1	x1	x1	x1	x1	x1



DENT PULLING DRAWN ARC ALU + STEEL

ACIER - STAHL



MANUAL



- Rings - Anneaux - Zugösen
- Studs - Goujons - Gewindebolzen
- Stainless steel nails - Tiges inox - Edelstahlnägel



- Start-up - Amorce - Zündung
- Scouring (I & t) - Décapage - Abbeizen
- Arc (I & t) - Arc - Lichtbogen
- Hitching (I & t) - Accroche - Verklebung
- Height - Hauteur - Höhe

7 languages
FR, EN, DE, SP, IT, NL & RU

SYNERGIC DIGITAL GUNS

★★★★★
UNIQUE Linear Motor

DRAWN ARC PROCESS
Gas protection

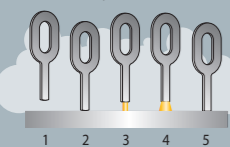

3 m, Ø 25 mm²
included
ARCPULL 200 & 350,
COMBI ARCPULL



Full control



Consumables for Gun



FV FLEXIBLE VOLTAGE

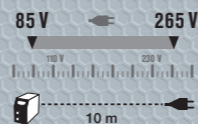

SR SECONDARY REGULATION

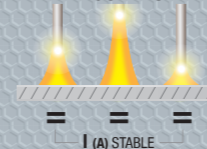

AD ANTI-DUST

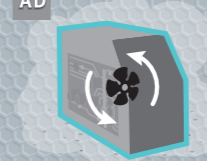

MANUAL & SYNERGIC CONTROL

2 GUNS INCLUDED



Ø max
Alu : 6 mm
Fe : 6 mm



GUN WITH CONNECTOR

GYSPOT ARCPULL 200 CAR BODY REPAIR

100 · 230V · 1~
200 A **T x1 MANUAL**
FV SR AD
057470
included

- Manual synergic gun 3 m, 25 mm² (x1) 059610
- ALU RING BOX 1.5 mm (AlSpec + AIMg3 + AIMgSi) 059429
- Lifting rod 180 mm (x1) 082915

OPTIONS details p.24
Weld 810 for ARCPULL 200 037489

GYSPOT COMBI ARCPULL

230V · 1~
ARCPULL 200 A + **EXPERT 3800 A**
Alu + Acier / Steel / Stahl
T x1 MANUAL + **T x1 MANUAL**

- 069824
- Arccpull accessories included
- Manual synergic gun 3 m, 25 mm² (x1) 059610
 - ALU RING BOX 1.5 mm (AlSpec + AIMg3 + AIMgSi) 059429
 - Lifting rod 180 mm (x1) 082915
- Expert accessories included
- Manual quick gun, 2 m, 70 mm² (057524) + Hammer (057272)
 - Earth cable 2 m, 70 mm²
 - SPOTTER BOX PRO (050075) (Details p.10)

MADE IN FRANCE 60974-1	50/60 Hz	I ₂ A	SYNERGIC			EXPERT			kW	OK	OK	LxWxH cm / kg	
			SYNERGIC	MANUAL	IRMS (A)	Acier/Steel	Alu	V					A
GYSPOT ARCPULL 200 CAR BODY REPAIR	110 · 230V	6 m	10 · 100 (110 V) 10 · 200 (230 V)	■	■	—	Manual + Digital Gun Motion Control	20.4 · 24 V (110 V) 20.4 · 28 V (230 V)	16	2.4 (110 V) 5.6 (230 V)	OK	OK	49 x 37 x 30 / 14.5
GYSPOT COMBI ARCPULL	230V	8 m	Alu 10 · 200 Acier 3800	■	■	Steel 3800	Manual Automatic (not included)	Alu 20.4 · 28 V Steel 7.4 V	16	Alu 5.6 Steel 20	OK	OK	72 x 42 x 29 / 41.5



GYSPOT ARCPULL

DENT PULLING DRAWN ARC ALU + STEEL ACIER - STAHL



SPECIAL TEARING RIVETS

Spécial arrachage de rivets - Spezial-Zugnieten

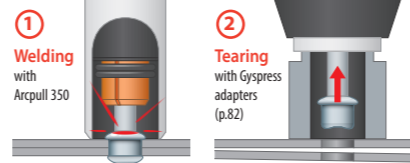

PFC POWER FACTOR CORRECTION

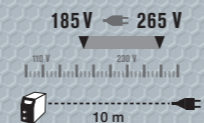

SR SECONDARY REGULATION

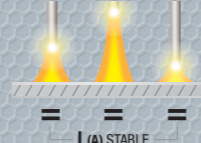

AD ANTI-DUST



- Rings - Anneaux - Zugösen
- Start-up - Amorce - Zündung
- Hitching (I & t)
- Studs - Goujons - Gewindebolzen
- Scouring (I & t) - Décapage
- Accroche - Verklebung
- Stainless steel nails - Tiges inox
- Abbeizen
- Height - Hauteur
- Edelstahlnägel
- Arc (I & t) - Arc - Lichtbogen
- Hohe

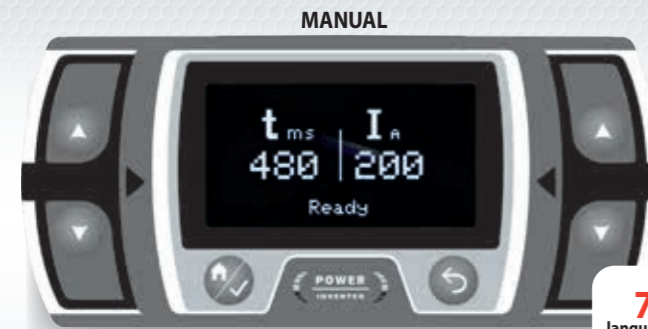

7 languages
FR, EN, DE, SP, IT, NL & RU



∅ max
Alu/Fe: 8 mm



∅ max
Alu: 10 mm
Fe: 13 mm



5 m, ∅ 50 mm² included
ARC PULL 700



Ideal all position

SYNERGIC DIGITAL GUNS

★★★★★ DRAWN ARC PROCESS
Gas protection

UNIQUE Linear Motor

3 m, ∅ 25 mm²

included ARCPULL 200, 350 & COMBI ARCPULL

FULL CONTROL

Consumables for Gun

- x2 059627
- x1 059610

GYSPOT ARCPULL 350 CAR BODY REPAIR

208 · 240V · 1~

350 A

x1 MANUAL

PFC SR AD

082953

included



Manual synergic gun
3 m, 25 mm²

ALU RING BOX 1.5 mm
(AlSpec + AlMg3 + AlMgSi)
059429

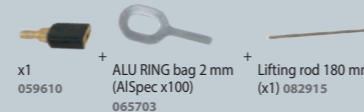

x1 059610

ALU RING bag 2 mm
(AlSpec x100)
065703

Lifting rod 180 mm
(x1) 082915

OPTIONS

details p.24

Weld 810
for ARCPULL 350
037489



GYSPOT ARCPULL 700 CAR BODY REPAIR

380 · 480V · 3~

680 A

x1 MANUAL

SR IP 23

OPTIONS

details p.24

Weld 910
for ARCPULL 700
070967



068315

included

- Manual synergic gun 5 m, 50 mm²
- Arc Pull Rivet Box 700
- Lifting rod 180 mm (x1) 082915
- Ground studs holder ∅ 6 (x1) 075368 ∅ 8 (x1) 075375 ∅ 10 (x1) 075382
- Threaded holder ∅ 5 (x1) 076174 ∅ 6 (x1) 068391
- Double earth clamps 700 A, 3 m, 50 mm² 068605
- ALU RING BOX 1.5 mm (AlSpec + AlMg3 + AlMgSi) 059429
- Gas protection (x1) 068346

MADE IN FRANCE 60974-1	50/60 Hz	6 m	I ₂ A	SYNERGIC	TECHNOLOGY		U ₂ V	A	kW	OK	OK	LxWxH cm / kg
					Acier/Steel	Alu						
GYSPOT ARCPULL 350 CAR BODY REPAIR	208 · 240V	6 m	10 · 350	■	Manual + Digital Gun Motion Control	■	20.4 · 34V	16	11.9	OK	OK	48 x 36 x 30 / 17.4
GYSPOT ARCPULL 700 CAR BODY REPAIR	3x 400V 3x 480V	5 m	50 · 680	■	Manual + Digital Gun Motion Control	—	22 · 44V	20 A (D) 16 A (D)	47.8 kW 45.7 kW	OK	OK	60 x 43 x 46 / 27.8





GYSPT ARC PULL 200, 350 & COMBI ACCESSORIES & CONSUMABLES

ACIER / STEEL / STAHL

x1 059634	x1 059641	x1 064065	x100 041561	x100 064034	x2 049000	x100 059603	x100 064607	x1 048157	x100 049383	x100 049413	x100 049420	x1 048164	x100 063969	x200 063990	x1 064041	x200 064003	x1 064058	x100 063976
STEEL STUDS BOX 200 & 350 059443	x1	x1	x1	x100	x1	x100	x100	x1	x100	x100	x100	x1	x100	x200	x1	x200	x1	x100

ALU

x1 059634	x1 059641	x2 049000	x100 059573	x1 048157	x100 059580	x1 048164	x100 059597	x200 064010	x1 064041	x200 064027	x1 064058	x100 063983	
ALU STUDS BOX 200 & 350 059436	x1	x1	x1	x100	x1	x100	x1	x100	x1	x100	x200	x100	

	straight rings						twisted rings							
	Al-Special		AlMg3		AlMgSi		Al-Special		AlMg3 - x 50		AlMgSi - x 50			
box	n°1 1mm	n°4 1.5mm	n°8 2mm	n°2 1mm	n°5 1.5mm	n°3 1mm	n°6 1.5mm	n°1 1mm	n°4 1.5mm	n°2 1mm	n°5 1.5mm	n°3 1mm	n°6 1.5mm	
	x100	x100	x100	x100	x100	x100	x100	x50	x50	x50	x50	x50	x50	
	059535	059559	065703	059498	059511	059450	059474	059542	059566	059504	059528	059467	059481	
box	ALU RING BOX 1 mm 059412		1mm x50		1mm x50		1mm x50		1mm x20		1mm x20		1mm x20	
box	ALU RING BOX 1.5 mm 059429		1.5mm x50		1.5mm x50		1.5mm x50		1.5mm x20		1.5mm x20		1.5mm x20	
sachet - bag	ALU RING BOX 2 mm 065703		2mm x100											

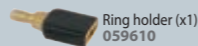

Earth clamp
Croco T400.70
043787



Double earth clamp
25 mm², 3 m, 350 A
070714



Joint rings for
mandrel Ø4/5/6
x2
060814

Mandrel support - Support porte-goujon x1 059634	Nozzle + pad - Buse + patin x1 059641	Ø2mm x1 064065	Ø4mm x2 049000	Ø5mm x1 048157	Ø6mm x1 048164	Ø7.1mm x1 064041	Ø8mm x1 064058
STUDS HOLDER BOX 350 064591	x1	x1	x1	x1	x1	x1	x1
ARCPULL DIFFICULT ACCESS BOX 350 070813	x1	x1					
Difficult access :							

x100 064607		x1 059634	x1 059641	x2 049000	x1 064683	x1 067721	x1 070738	x100 070745	x1 066151		
ARCPULL RIVET BOX 1 350 - 24kN 064584	x100	x1	x1	x1	x1	x1					
ARCPULL RIVET BOX 2 350 - 50 kN 073388			x1	x1				x1	x100	x1	

GYSPT ARC PULL 700 - ACCESSORIES & CONSUMABLES

x100 070745	x1 070738	x1 066151	x1 071377	x1 059641	x1 059610	x1 071384	x1	Ø6 x1 075368	Ø8 x1 075375	Ø10 x1 075382	Ø5 x1 076174	Ø6 x1 068391	Ø8 x1 068407
ARCPULL RIVET BOX 700 068452	x100	x1		x1	x1	x2	x1	x1	x1	x1			



FAST DENT PULLING

STEEL / ACIER / STAHL

EASY TOOL CONNECTION



for GYSPOT 39.02/04, PRO 230/400, EXPERT 230/400, COMBISPOT 230



051690

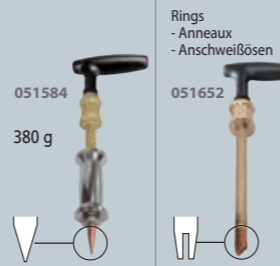

051584
380 g

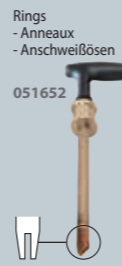

051652

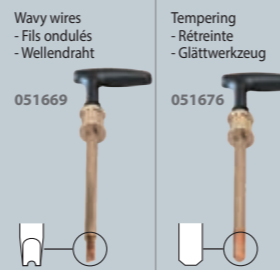

051669



051676



Manual dent-pulling bar - Poignée de tirage manuel 057289



EASYGUN 051317

MANUSPOT = 050679



Tools set and support for DENT 600, 800, 1000, 1600, Workstation & Dentstation



EASYGUN 051317



MANULINER 050471

3 m Ø 35 mm2

PATENTS REGISTERED NUMBERS 001652108-0003 EUROPEAN TRADEMARK & DESIGN

4 positions 4 Positionen

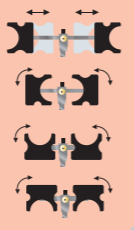

FAST & EASY



RINGMATIC 052154

included (x 50)



Option Gun adapter - Adaptateur pistolet 052499

Box of 3 electrodes for accessories 050822



MANULINER/GUN 056831

PATENTS REGISTERED NUMBERS 001652108-0003 EUROPEAN TRADEMARK & DESIGN



Gun adapter - Adaptateur pistolet included 052499

Pads - Patins (x2) 060807

DENT AXE PULLER 080508

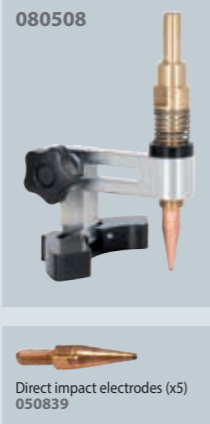

Direct impact electrodes (x5) 050839

QUICK SPOT AIR GUN V2 057340



LIGHT 920 g

AIR

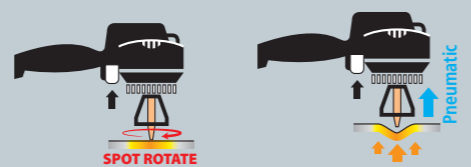

SPOT ROTATE

Pneumatic

Gun adapter - Adaptateur pistolet 052826

MANU PULLER 079502

079502



Included Alu 3 065178

Included Steel 079830

Included Alu 4 065185



ALU

ARC PULLER PREMIUM 065161



Included Alu 3 065178

Included Alu 4 065185

Pads - Patins (x2) 069008

ULTRA RESISTANT No deformation

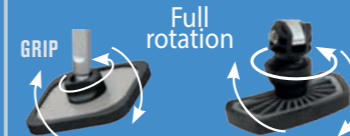

Full rotation

GRIP



Multi positions

ARC PULLER PREMIUM PRO 072572



Pads - Patins (x4) 074958

Included Alu 3 065178

Included Alu 4 065185

ALU PULLER

4 positions

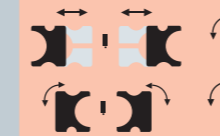

= 051003



Included Alu 1 050938



Included Alu 2 050945

Patins - Pads (x2) 060807

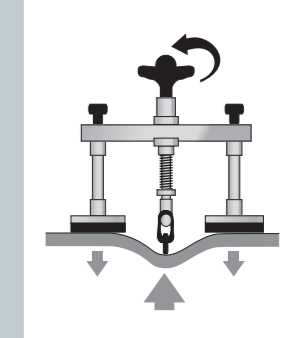

STRAIGHT LINE LAMP - Lampe ligne droite - Dentline-laser 056770

- Lampe ligne droite - Dentline-laser



FAST PULLING RINGS - Anneaux de tirage rapide 058743

- Anneaux de tirage rapide

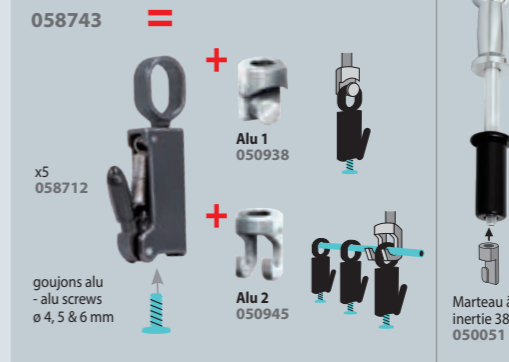

x5 058712

Alu 1 050938

Alu 2 050945

goujons alu - alu screws ø 4, 5 & 6 mm

Marteau à inertie 380 g 050051

ALU HAMMERS - Marteaux alu 020986

- Marteaux alu



SUPER ERGONOMIC

BREVET GYS PATENT PENDING GYS PATENT



QUICK HOOK

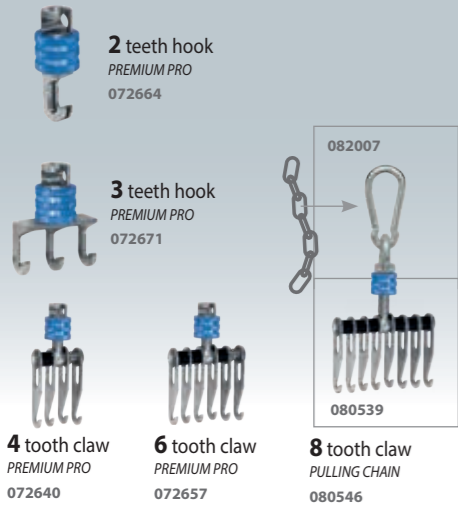

EASY REMOVABLE PULLING SYSTEM

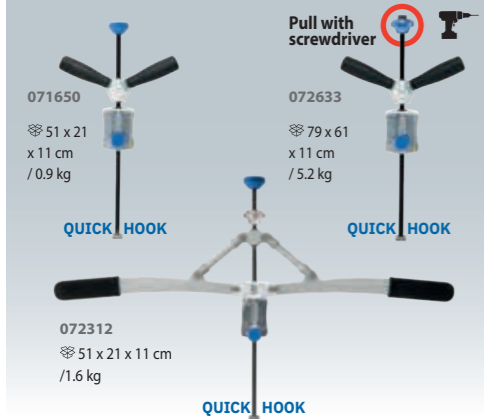
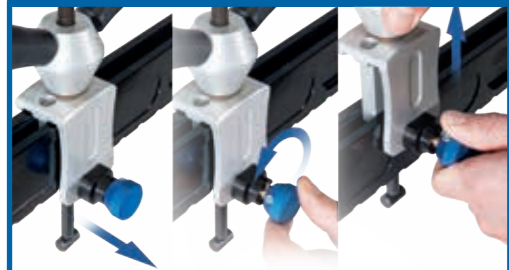

SLIDE & LOCK



PREMIUM PRO

Premium Pro Levelling lever
- Levier de débousselage Premium Pro
- Premium Pro Zughebel

072619
1.6 kg
87 x 17 x 18 cm / 2.3 kg

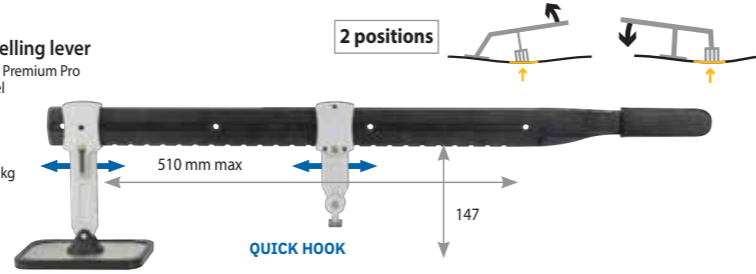

Premium Pro Levelling bar 900mm / Single feet
- Barre de débousselage Premium Pro 900 mm
- Premium Pro Zugbrücke 900 mm

071643
120 x 26 x 8 cm / 4.4 kg
3.8 kg

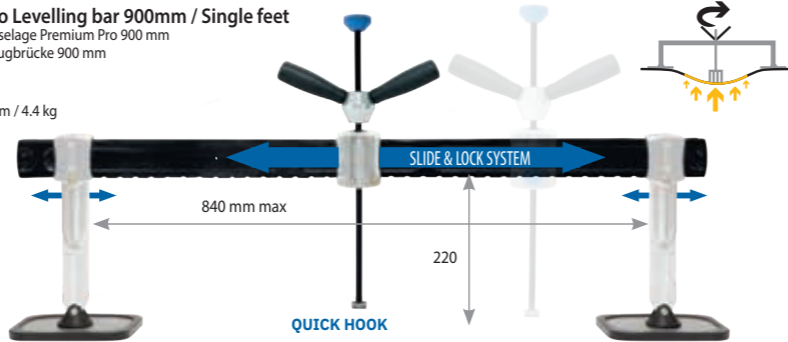

Premium Pro Levelling bar 900mm / Double feet
- Barre de débousselage Premium Pro 900 mm
- Premium Pro Zugbrücke 900 mm

080102
3.8 kg

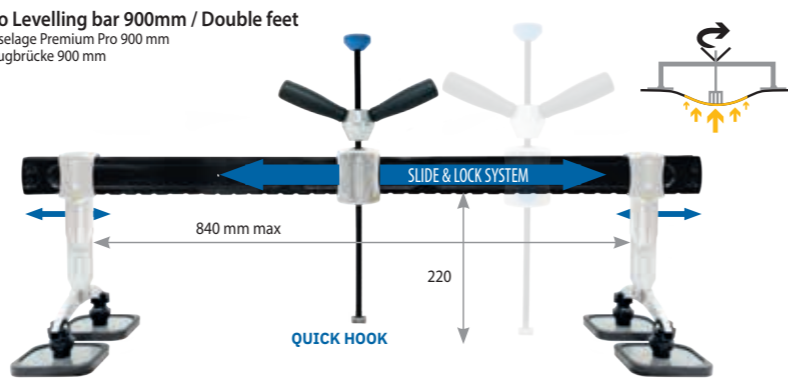

Premium Pro Scissoring bar 900mm
- Barre de tirage Premium Pro 900 mm
- Premium Pro Scherenzugbrücke 900 mm

072305
103 x 30 x 13 cm / 5.2 kg
4.5 kg

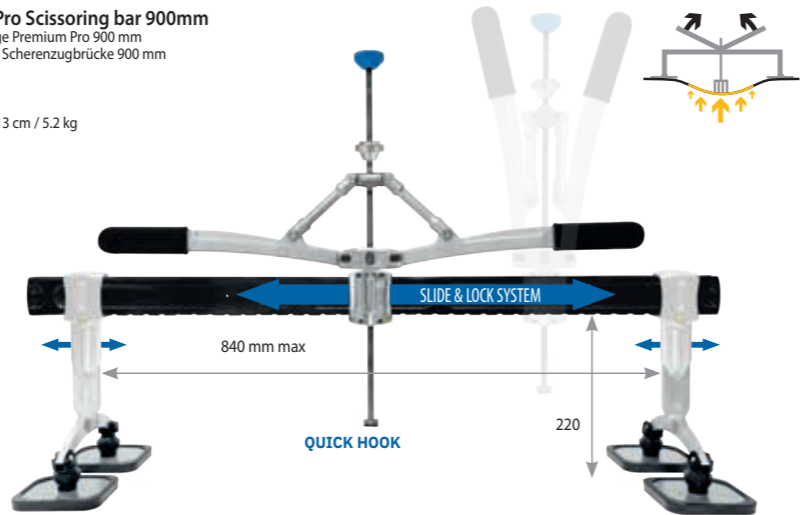

Premium Pro Scissoring bar 1150 mm
- Barre de tirage Premium Pro 1150 mm
- Premium Pro Scherenzugbrücke 1150 mm

072626
124 x 7 x 7 cm / 3.1 kg



PREMIUM BAR SMART HAND

for Premium & Premium Pro
072480





DENT PULLING WORKSTATIONS

**A COMPLETE SOLUTION
UNE SOLUTION COMPLÈTE
KOMPLETTLÖSUNGEN**

Compatibility

SPOT	Dent 600	Dent 1000	Universal 800	Weld 810	Weld 910	Dent 1600	Dent 1600 WD	Dentstation Pro WD
26/27.02	✓	✓	✓	✓		✓		✓
34.02/04	✓	✓	✓	✓		✓		✓
39.02/04	✓	✓	✓	✓		✓		✓
PRO 230/400	✓	✓	✓	✓		✓		✓
EXPERT 230/400	✓	✓	✓	✓		✓		✓
ALU 66	✓	✓	✓					✓
ALU PRO FV	✓	✓	✓					✓
COMBI 230 E.PRO						✓		✓
ARCPULL 200/350				✓	✓	✓		✓
COMBI ARCPULL						✓		✓
ARCPULL 700					✓	✓		✓

Universal 800
 ↳ 60 x 48 x 83 cm
 17,6 kg
 ↳ 79 x 39 x 18 cm
 18,1 kg
 051331

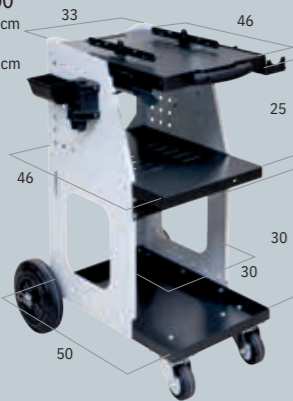

Weld 810
 ↳ 77 x 50 x 84 cm
 20,1 kg
 ↳ 80 x 51 x 14 cm
 21,6 kg
 037489

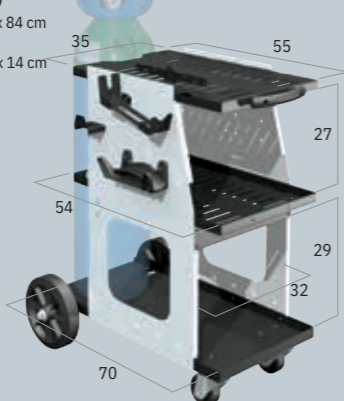

Weld 910
 ↳ 89 x 52 x 84 cm
 25 kg
 ↳ 80 x 52 x 22 cm
 27 kg
 070967

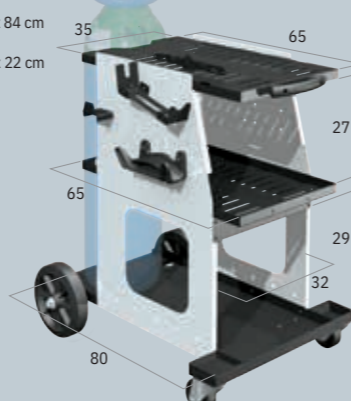

Dent 1600
 ↳ 70 x 69 x 161 cm
 / 35,8 kg
 ↳ 103 x 66 x 22 cm
 / 38,7 kg
 072596

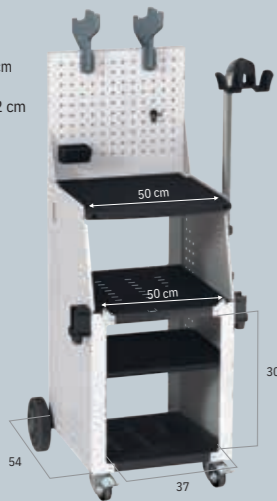

Dent 1600 WD
 ↳ 71 x 70 x 161 cm
 / 49,5 kg
 ↳ 103 x 66 x 22 cm
 / 52,4 kg
 072169

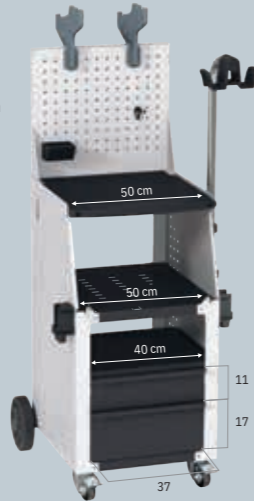

Dentstation Pro WD
 ↳ 90 x 71 x 161 cm
 / 65 kg
 ↳ 120 x 80 x 28 cm
 / 68,5 kg
 072800



CHARIOTS / TROLLEYS

Dent 600
 ↳ 44 x 35 x 62 cm / 6,9 kg
 ↳ 60 x 39 x 14 cm / 7,4 kg
 072831

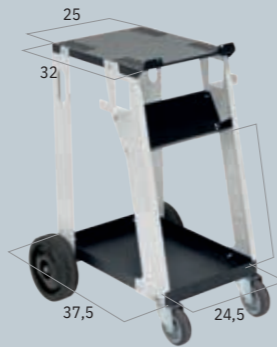

Dent 1000
 ↳ 44 x 35 x 98 cm / 9,3 kg
 ↳ 60 x 39 x 14 cm / 9,9 kg
 072848



Cable support for Spot 800, 1600 & Dentstation Pro WD
 052284



Protection cover - Housse de protection - Schutzhaube
 for Universal 800
 062733
 for Spot 1600 & Dent 1600
 048881
 for Dentstation Pro
 059870

EASYLINER



EASYLINER 39.02

EASYLINER PRO 230

STEEL / ACIER / STAHL



GYSPOT (guns & consumables included)

39.02
 053618
 ☎ : 058521

PRO 230
 072398



INCLUDED ACCESSORIES



DENT 1000
 072848



Dent box easy
 053632



Levelling bar double action
 053564

PROLINER



PROLINER 39.02
 PROLINER 39.04

PROLINER PRO 230
 PROLINER PRO 400

STEEL / ACIER / STAHL



GYSPOT (guns & consumables included)

39.02
 035775
 39.04
 035782

PRO 230
 035799
 PRO 400
 035805

INCLUDED ACCESSORIES



UNIVERSAL 800
 051331
 + Cable support
 052284



Dent box easy
 050037

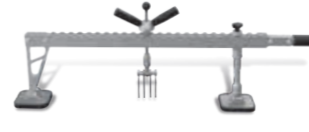

Levelling bar double action
 053564



PROLINER ALU PRO FV

PROLINER ARCPULL 200

ALU



GYSPOT (guns & consumables included)

ALU PRO FV
 035836

ARCPULL 200
 065260



UNIVERSAL 800
 051331
 + Cable support
 052284



Weld 810
 037489
 + Cable support
 052284



Alu puller
 051003



Arc puller premium
 065161

SPEEDLINER STANDARD

COMPLETE
SYSTEM



PRO 230, 400 EXPERT 200, 230, 400 COMBI 230 E.PRO ARCPULL 200 + PRO 230, 400 ARCPULL 200 + EXPERT 200, 230, 400 ALU PRO FV

STEEL / ACIER / STAHL



GYSPOT
(guns & consumables included)



GYSPOT
(guns & consumables included)



GYSPOT
(guns & consumables included)



GYSPOT
(guns & consumables included)

PRO 230 074446	EXPERT 200 074460	COMBI 230 E PRO 074491	ARCPULL 200 + PRO 230 074507	ARCPULL 200 + EXPERT 200 074521	ALU PRO FV 074552
PRO 400 074453	EXPERT 230 074477		ARCPULL 200 + PRO 400 074514	ARCPULL 200 + EXPERT 230 074538	
	EXPERT 400 074484			ARCPULL 200 + EXPERT 400 074545	

INCLUDED ACCESSORIES

DENT 1600 072596	Cable support 052284	Levelling bar 850 mm 050693	052451
Magnetic earth 049666	Multihook heads 049758+049734	Levelling bar 050686	Ringmatic 052154
Alu puller 051003	Cable support 052284	Arc puller premium 065161	Cable support 052284 + 4 m support 059665
Stainless steel brush 044258	Alu Box 05 & 6 048195	Infrared Thermometer 079922	Hot air gun 650°C 066311

INCLUDED ACCESSORIES

DENT 1600 072596	Cable support 052284
Levelling bar 850 mm 050693	Levelling bar 850 mm 050693
Alu hammers 020986	Set of pencil punches with 6 teflon tips 052888
Multihook heads 049758	Alu puller 051003
Stainless steel brush 044258	Alu Box 05 & 6 048195
Infrared Thermometer 079922	Hot air gun 650°C 066311

Steel Speedliner without generator (excluded Ringmatic) : 035058

SPEEDLINER PREMIUM

★★★★
COMPLETE SYSTEM



PRO 230, 400



EXPERT 200, 230, 400



COMBI 230 E.PRO



ARCPULL 200
+ PRO 230, 400



ARCPULL 200
+ EXPERT 200, 230, 400



ARCPULL 200, 350



STEEL / ACIER / STAHL



GYSPOT
(guns & consumables included)



GYSPOT
(guns & consumables included)



GYSPOT
(guns & consumables included)

ALU



GYSPOT
(guns & consumables included)

PRO 230 073883	EXPERT 200 073906	COMBI 230 E PRO 073968	COMBI ARCPULL 074569	ARCPULL 200 + PRO 230 073975	ARCPULL 200 + EXPERT 200 073913	ARCPULL 200 073999	ARCPULL 350 083042
PRO 400 073890	EXPERT 230 073920			ARCPULL 200 + PRO 400 073982	ARCPULL 200 + EXPERT 230 073937	077317 (without HOT AIR GUN)	
	EXPERT 400 073944				ARCPULL 200 + EXPERT 400 073951		

INCLUDED ACCESSORIES

DENT 1600 WD 072169	Cable support 052284	Premium levelling bar 720 mm 059306
Hook head 049758 + 059658 + 059382	Premium levelling lever 059290	
Magnetic earth 049666	Manuspot 050679	Dent box consumables 051515 + 3 lifting rods 050792
Fast pulling rings (x5) 058712 + Alu puller 051003 + Cable support 052284	Arc puller premium 065161	Cable support 052284 4 m³ support 059665

INCLUDED ACCESSORIES

DENT 1600 WD 072169 Cable support 052284	Alu Ring Box 1 mm 059412 Premium 2-teeth hook 059382
Arc puller premium 065161	Premium levelling bar 720 mm 059306
Alu hammers 020986	Infrared Thermometer 079922 Hot air gun 650°C 066311
Set of pencil punches with 6 teflon tips 052888	3 lifting rods 050792
Stainless steel brush 044258	4 m³ support 059665

SPEEDLINER PREMIUM PRO



PRO 230, 400



EXPERT 200, 400
+ ARCPULL 200, 350



COMBI ARCPULL



ARCPULL 200, 350

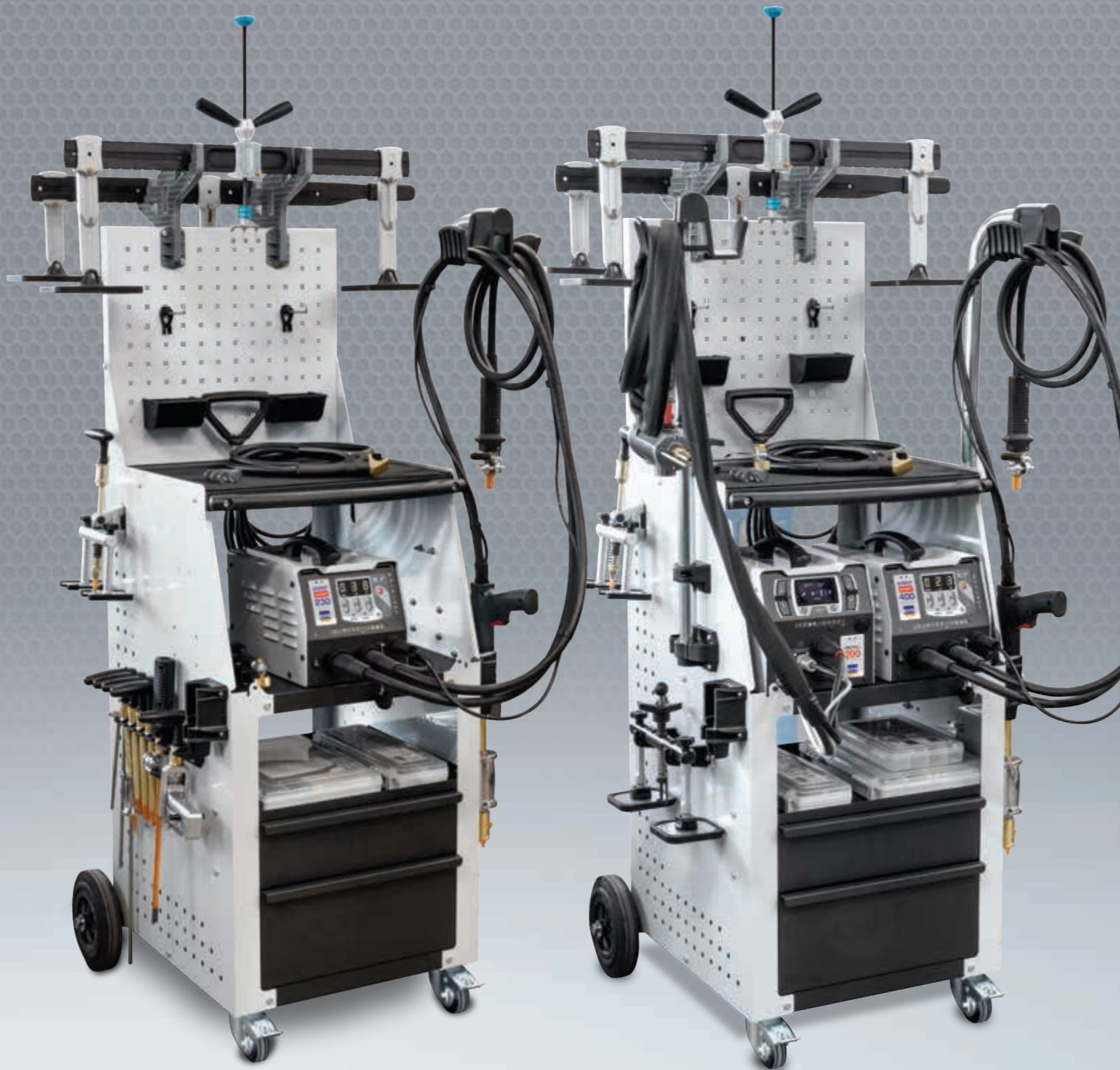

STEEL / ACIER / STAHL



GYSPOT
(guns & consumables included)

ALU + STEEL / ACIER / STAHL



GYSPOT
(guns & consumables included)



GYSPOT
(guns & consumables included)

ALU



GYSPOT
(guns & consumables included)

EXPERT 230	EXPERT 400	EXPERT 400 + ARCPULL 200	EXPERT 400 + ARCPULL 350	COMBI ARCPULL	ARCPULL 200	ARCPULL 350
080201	080218	080232	083028	080225	080256	083035
		EXPERT 200 + ARCPULL 200				
		080553				

INCLUDED ACCESSORIES



Dent 1600 WD
072169



Premium Pro levelling bar 900 mm
071643



Premium Pro levelling bar
072619



Ringmatic
052154



Manuspot
050679



Premium Pro teeth hook
072671 + 072664 + 072640



Manual pulling handle
057289

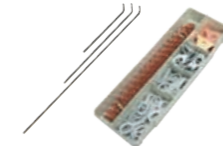

3 lifting rods
050792
Dent box consumables
051515



Magnetic earth
049666



Cable support
052284
4 m support
059665
Arc Puller Premium Pro
072572

INCLUDED ACCESSORIES



Dent 1600 WD
072169



Alu Ring Box 1 mm



072664



4 m support
059665



Premium Pro levelling bar 900 mm
071643



Set of pencil punches with 6
teflon tips
052888



Arc Puller Premium Pro
072572



Alu hammers
020986



Infrared Thermometer
079922
Hot air gun 650°C
066311



Stainless steel brush
044258



3 lifting rods
050792

DENTSTATION STANDARD



39.02, 39.04 PRO 230, 400 EXPERT 200, 230, 400 COMBI 230 E.PRO ARCPULL 200 + PRO 230, 400 ARCPULL 200 + EXPERT 200, 230, 400

COMPLETE SYSTEM

STEEL / ACIER / STAHL



GYSPOT
(guns & consumables included)

ALU + STEEL / ACIER / STAHL



GYSPOT
(guns & consumables included)



GYSPOT
(guns & consumables included)

39.02	PRO 230	EXPERT 200	COMBI 230 E PRO	ARCPULL 200 + PRO 230	ARCPULL 200 + EXPERT 200
078161	078208	078321	078529	078222	078338
39.04	PRO 400	EXPERT 230		ARCPULL 200 + PRO 400	ARCPULL 200 + EXPERT 230
078185	078260	078369		078284	078384
		EXPERT 400 078444			ARCPULL 200 + EXPERT 400 078468



INCLUDED ACCESSORIES

<p>Dentstation Pro WD 072800 Fixing kit 051362</p>	<p>Double pads 050723</p>	<p>Levelling bar 850 mm 050693</p>	<p>Scissoring bar 050716</p>
<p>Magnetic earth 049666</p>	<p>Multihook heads 049758 +049734 +049741</p>	<p>Levelling lever 050686</p>	<p>Strengthened bar 1200 mm 051171 Extensions (x2) 052451</p>
<p>Fast pulling rings (x5) 058712 + Alu puller 051003</p>	<p>Manuspot 050679</p>	<p>Dent box consumables 051515 3 lifting rods 050792 Empty box 320x113mm</p>	<p>Manual pulling handle 057289</p>
<p>Cable support 052284</p>	<p>Arc puller premium 065161</p>	<p>Cable support 052284 + 4 m support 059665 + Flanges (x 2) 062146</p>	<p>Ringmatic 052154</p>

DENTSTATION PREMIUM



PRO 230, 400



EXPERT 200, 230, 400



COMBI 230 E.PRO
COMBI ARCPULL



ARCPULL 200
+ PRO 230, 400



ARCPULL 200
+ EXPERT 200, 230, 400

★ ★ ★ ★
COMPLETE SYSTEM

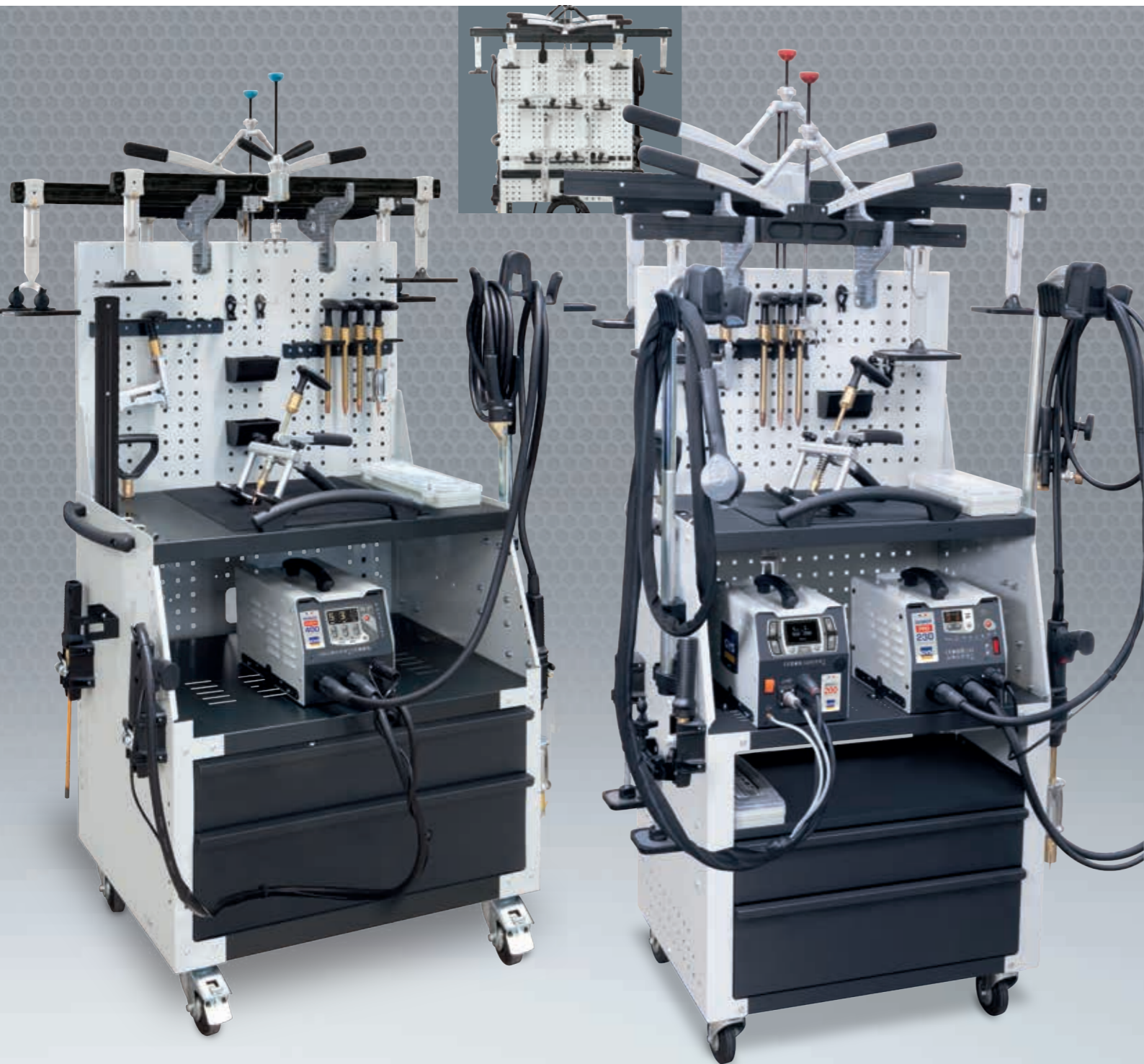

STEEL / ACIER / STAHL



GYSPOT
(guns & consumables included)

ALU + STEEL / ACIER / STAHL



GYSPOT
(guns & consumables included)



GYSPOT
(guns & consumables included)

PRO 230 078239	EXPERT 200 078345	COMBI 230 E PRO 078543	COMBI ARCPULL 078567	ARCPULL 200 + PRO 230 078253	ARCPULL 200 + EXPERT 200 078352
PRO 400 078291	EXPERT 230 078406			ARCPULL 200 + PRO 400 078314	ARCPULL 200 + EXPERT 230 078420
	EXPERT 400 078482				ARCPULL 200 + EXPERT 400 078505

INCLUDED ACCESSORIES

x6 x2	Manuspot 050679	Premium levelling bar 720 mm 059306	Premium levelling lever 059290
Dentstation Pro WD 072800 Fixing kit 051362	Hook head 049734 + 059658 + 059382	Premium scissoring bar 720 mm 058996	Premium scissoring bar 1200 mm 059313
Magnetic earth 049666	Premium double pads support 150 mm (x2) 059351 + 220 mm (x2) 059375	Dent box consumables 051515 3 lifting rods 050792 Empty box 320x113mm	Manual pulling handle 057289
		Ringmatic 052154	

Fast pulling rings (x5) 058712 Alu puller 051003 Cable support 052284	Cable support 052284 4 m ² support 059665 Flanges (x 2) 062146 Arc puller premium 065161	Arc puller premium 065161 Cable support 052284 4 m ² support 059665 Flanges (x 2) 062146
---	---	---

DENTSTATION PREMIUM PRO



EXPERT 230, 400



COMBI ARCPULL



EXPERT 400 + ARCPULL 200, 350



ARCPULL 200, 350

STEEL / ACIER / STAHL



1 BOX GYSOT (guns & consumables included)

ALU + STEEL / ACIER / STAHL



1 BOX GYSOT (guns & consumables included)

ALU



1 BOX GYSOT (guns & consumables included)

EXPERT 230	EXPERT 400	EXPERT 400 + ARCPULL 200	EXPERT 400 + ARCPULL 350	COMBI ARCPULL	ARCPULL 200	ARCPULL 350
080133	080140	080164	083004	080157	080461	083011

INCLUDED ACCESSORIES



1 BOX Dentstation Pro WD 072800



Premium pro levelling bar 900mm 071643



Premium pro levelling lever 072619
Premium pro bar 1184 mm 072626



Manuspot 050679

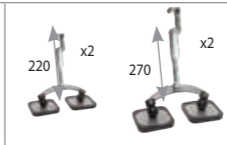

(x2) 059375 + (x2) 072688



072664 + 072671 + 072640 + 072657



071650 + 072312

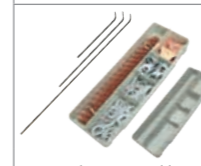

Dent box consumables 051515
3 lifting rods 050792
Empty box 320x113mm



Magnetic earth 049566
Ringmatic 052154
Manual pulling handle 057289

1 BOX STEEL ACCESSORIES PACK V2 080126

INCLUDED ACCESSORIES



1 BOX Dentstation Pro WD 072800



Premium pro levelling bar 900mm 071643 (x2) 059375



072664 + 072640 + 071650 Alu Ring Box 1 mm 059412



Alu hammers 020986



Arc Puller Premium Pro 072572



Set of pencil punches with 6 teflon tips 052888



3 lifting rods 050792



Stainless steel brush 044258
Infrared Thermometer 079922
Hot air gun 650°C 066311

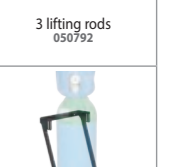

4 m³ support 059665

1 BOX ARCPULL ACCESSORIES PACK 080485



Cable support 052284
4 m³ support 059665
Arc Puller Premium Pro 072572

1 BOX ALU ACCESSORIES PACK 073838

1 BOX ARCPULL ACCESSORIES PACK 080485



PULLING SYSTEMS

AIRFIX DRAW ALIGNER	38
DRAW ALIGNER	40
FRAME STRAIGHTENING	42



DRAW ALIGNER



- Designed for
- ★ TIME SAVING
 - ★ DURABILITY
 - ★ MAXIMUM GRIP

4 pads :
**Seal protection,
Perfect stability**

4 patins : protection du joint, stabilité parfaite
4 Pads: Dichtungsschutz, perfekte Stabilität
4 piedini: protezione sigillata, perfetta stabilità

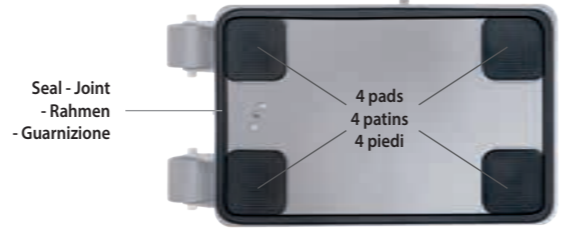

Quick & easy set up

Compact & light
31 kg

No tools

Fast installation

Ground anchor by suction

Ancrage au sol par aspiration : installation rapide
Verankerung durch Vakuumbildung – schnell einsatzfähig
Ancoraggio a terra: installazione rapida

Low noise

Integrated silencer

Smart maintenance

No glue No tools

12 tooth claw - Griffes 12 dents 082229



AIRFIX DRAW ALIGNER

Air 5-8 bars
077379
080669

Option

XL mast for Airfix Draw Aligner - Mât XL - XL-Mast
083714

Ergonomic

079588 Ultra resistant No elasticity (1,5 T max) (included)

049734 Ø M10 / M14 (included)

included Strap - Sangle

350 kg

1.30 m → 2.05 m

200 cm

118 x 27 x 25 cm 21 kg

1.3 m

NEW 07/2024

350 kg Uniform pulling force

Force de tirage uniforme
Gleichmäßige Zugkraft
Forza di spinta uniforme

Precision
All directions

Down-pulling
Rocker panel - Bas de caisse - Schweller - Sottoporta

Up-pulling
Upper-parts - Parties hautes - Oberteile

Options

Welding sheets kit - Kit plaques à souder 083493

NEW

25 mm (x1 included) x5 083509

38 mm (x1 included) x5 083516

50 mm (x1 included) x5 083523

75 mm (x1 included) x5 083530

PULLING SYSTEMS

**DRAW ALIGNER**

Draw aligner - Équerre de tirage - Schnellausbeul-Richtausleger
052475

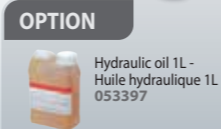
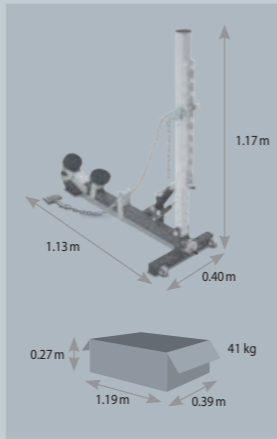
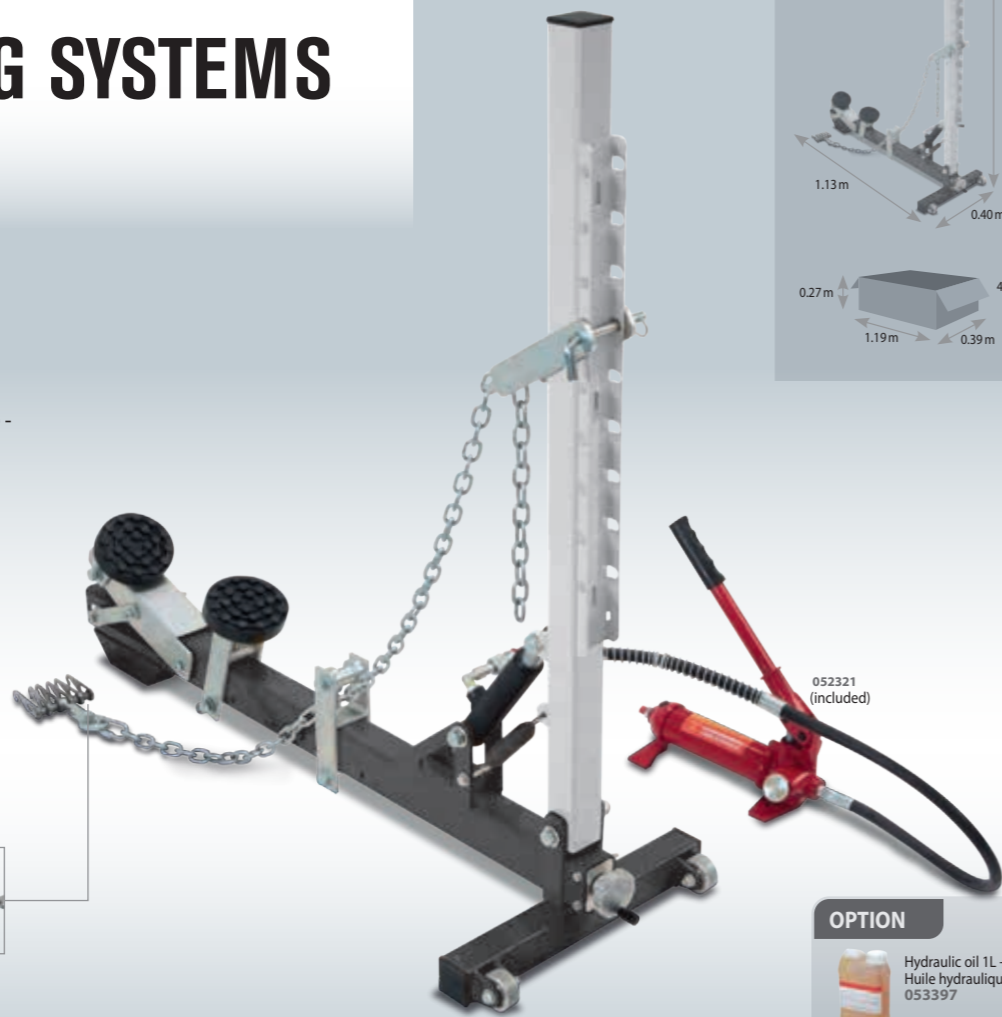
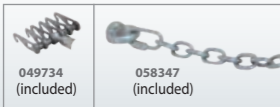
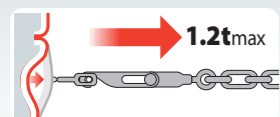
**INCLUDED**

Wedge for rocker panel - Cône pour bas de caisse

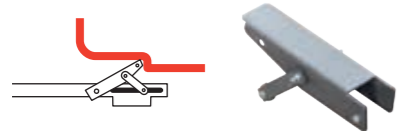

Pads kit for rocker panel - Kit patins pour bas de caisse

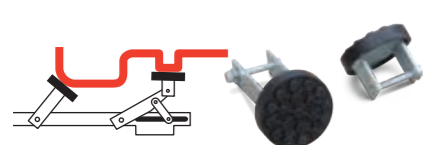
**OPTION**

Rocker panel arms for draw aligner - Bras de bas de caisse - Abstütztraverse für Richtausleger

052581

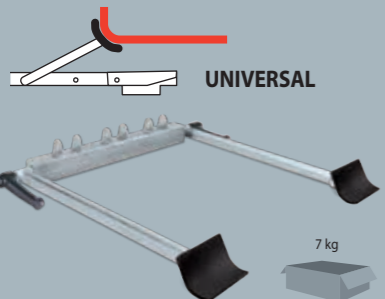
**UNIVERSAL**

7 kg

OPTION

12 tooth claw for pulling chain
082229

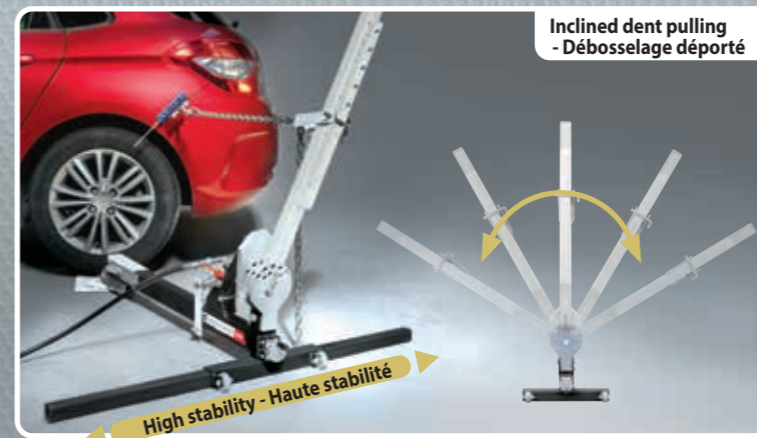
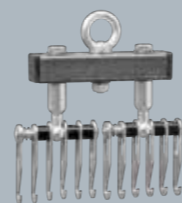
**DRAW ALIGNER PRO**

069244

**INCLUDED**

Plate under the wheel - Cône sous roue
Compatible with Draw Aligner & Draw Aligner Pro 076693



Wedge for rocker panel - Cône pour bas de caisse

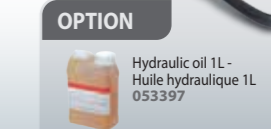
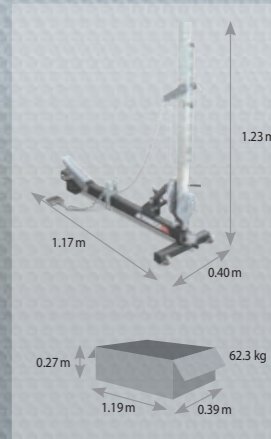
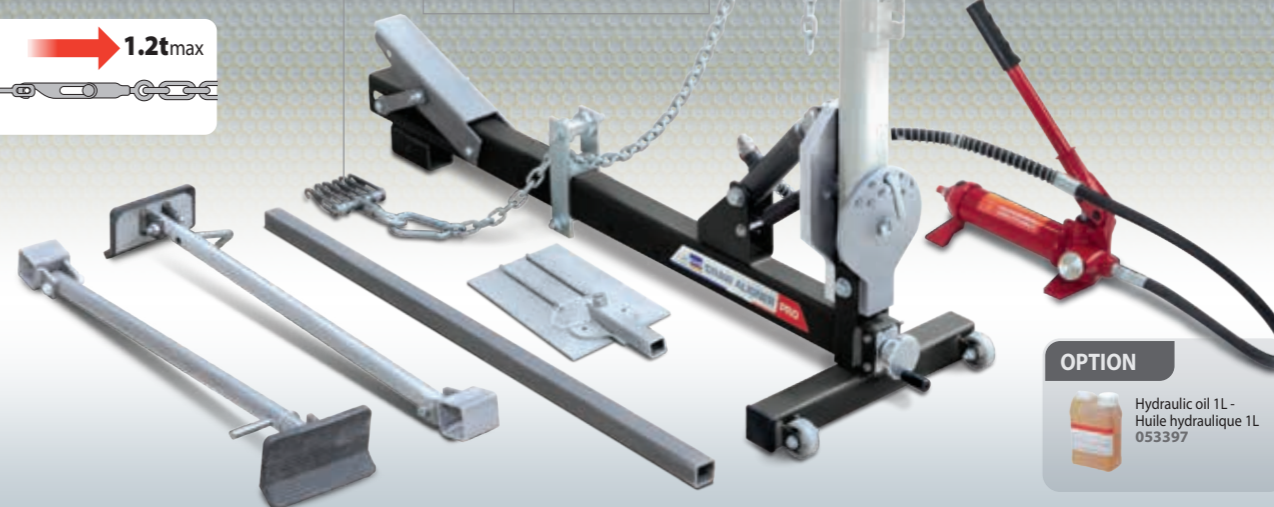
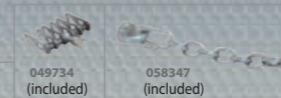
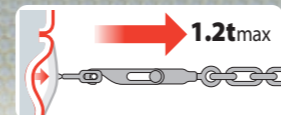

Rocker panel arms and stabilisation bar - Kit bras de bas de caisse et barre de stabilisation

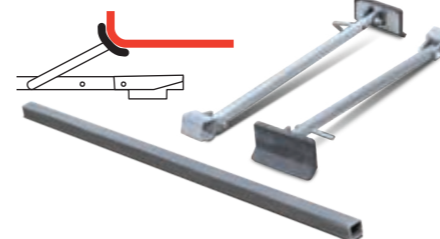
**OPTIONS**

Pads kit for rocker panel - Kit patins pour bas de caisse
071278

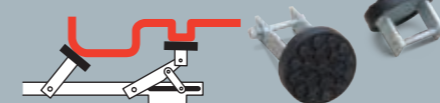

ELECTRO POWER - Zug-Druckpresse

with accessories : 057425



INCLUDED

Accessories kit : 425x620x150 mm
Accessories kit
Total weight: 20 kg



057418

Standard kit : 425x620x210 mm
Standard kit
Total weight: 18 kg



057401

Li-Ion battery 058514

OPTION

Pince écarteur 079496

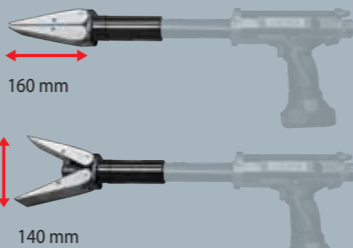

160 mm

140 mm

-PULLING POWER: 5 Ton.
-PUSHING POWER: 5 Ton.
-PISTON
-STROKE: 130 mm

Spreading / Estensione

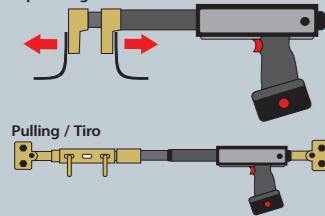

Pressing / Compressione

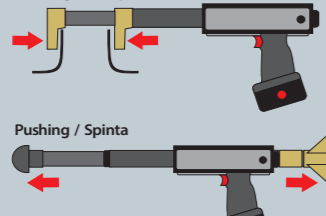

Pulling / Tiro

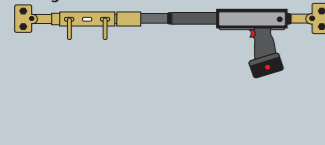

Pushing / Spinta

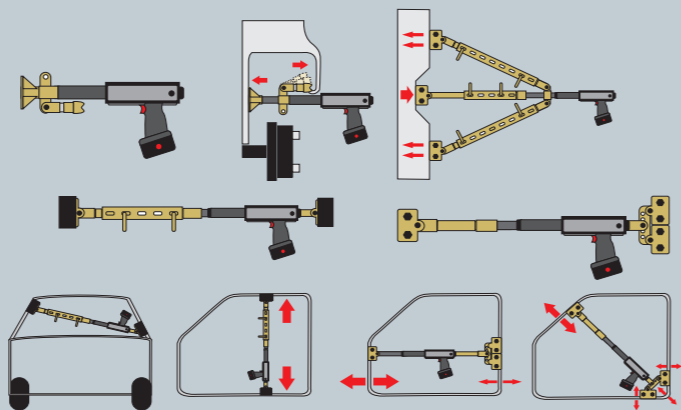
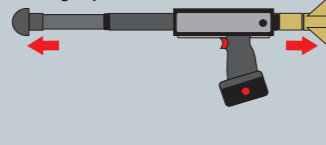

ANCHOR BAR - Barre d'ancrage - Türspanner

MADE IN TAIWAN

053045



053052



INERTIA HAMMER KIT - Kit marteau à inertie - Ausziehhammer kit

Inertia hammer kit
- Kit marteau à inertie
- Ausziehhammer kit
051928

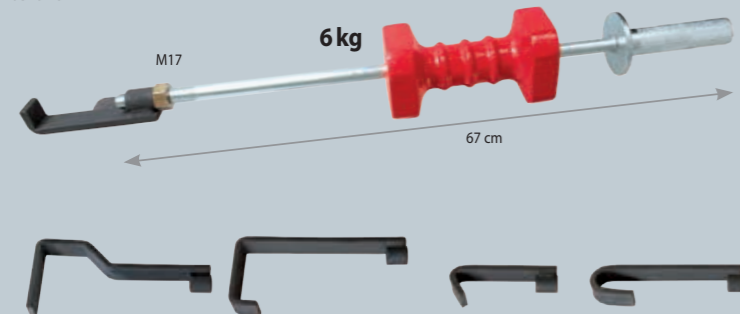

POWER-PULLER 4T

059740



HYDRAULIC CYLINDER KIT - Coffret vérin hydraulique - Hydraulischer Drucksatz

MADE IN CHINA

OPTION



Hydraulic oil 1L - Huile hydraulique 1L 053397

BASIC 4T
052345



BASIC 10T
052338

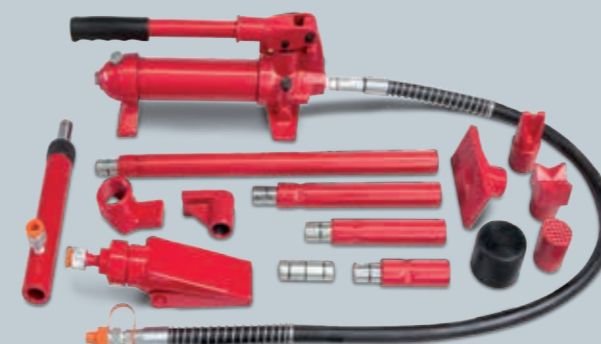

PRO 4T
057432



PRO 10T
057449



MEASURING TOOLS - Mesures - Vermessung

BODYMETER, Mechanical measurements

052130



GYSMETER, Electronic measurements

052093



Measuring report

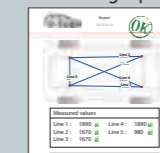

Light weight measuring arm with an easy to read digital display

SWIVEL CLAMP
- Pince pivotante



PULL CLAMPS - Pincés de tirage - Ziehwerkzeuge

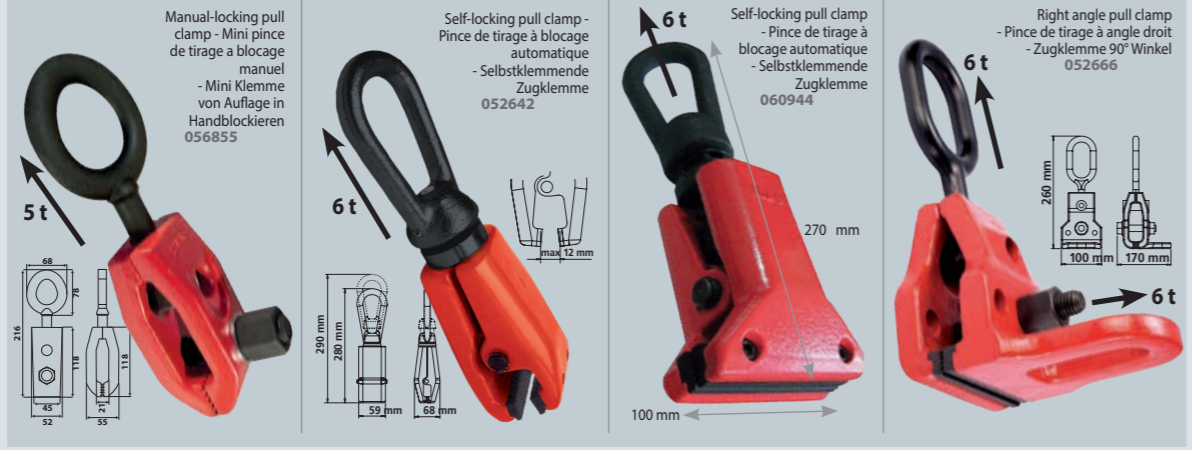

PULL HOOK - Crochet de tirage - Ziehwerkzeuge

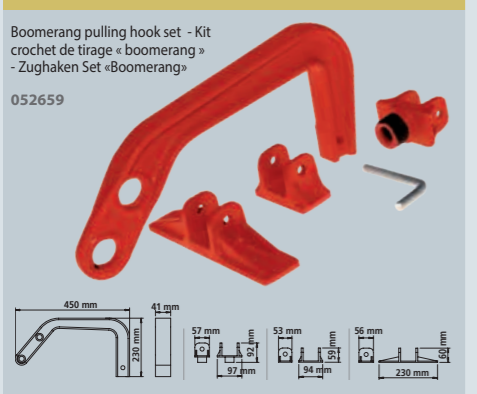

ARCH HOOKS - Passage de roue

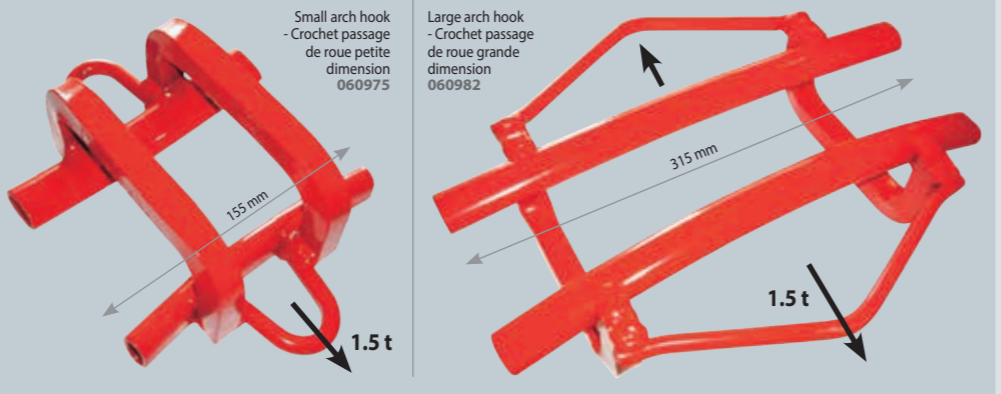

PULLING CHAIN - Chaînes de tirage - Ziehwerkzeuge

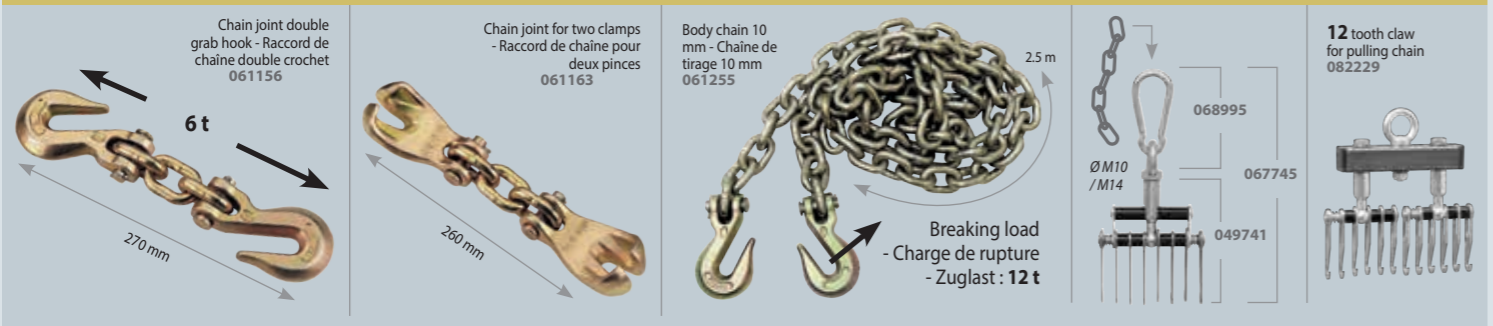

WIDE PULL CLAMPS - Pincés de tirage larges

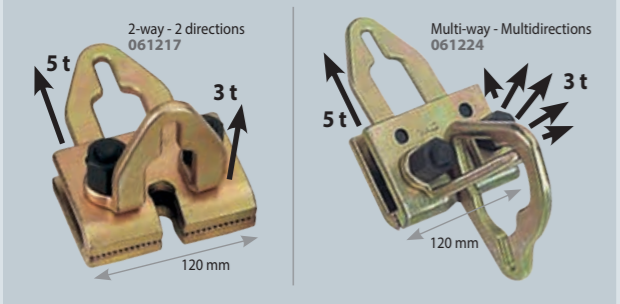

SMALL PULL CLAMPS - Pincés de tirage faible largeur

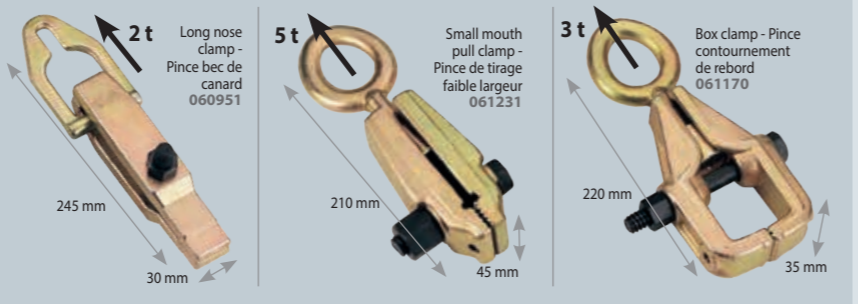

MULTIPLE PULL CLAMP
- Pince de tirage multiple

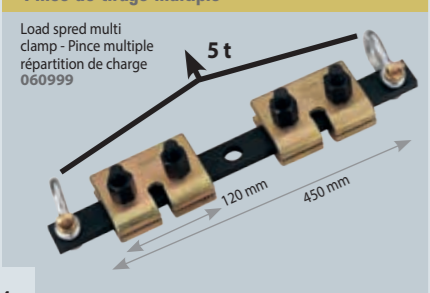

45 MM SCISSORS CLAMP
- Pince ciseaux largeur 45 mm

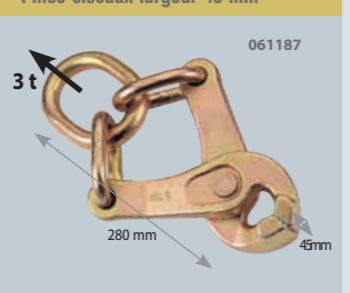

90 DEGREE CORNER CLAMP
- Pince de tirage pour angle 90°



C TYPE CLAMP
- Pince de tirage type C



SMART SATELLITE - Satellite intelligent- Satellite Komplett-Kit

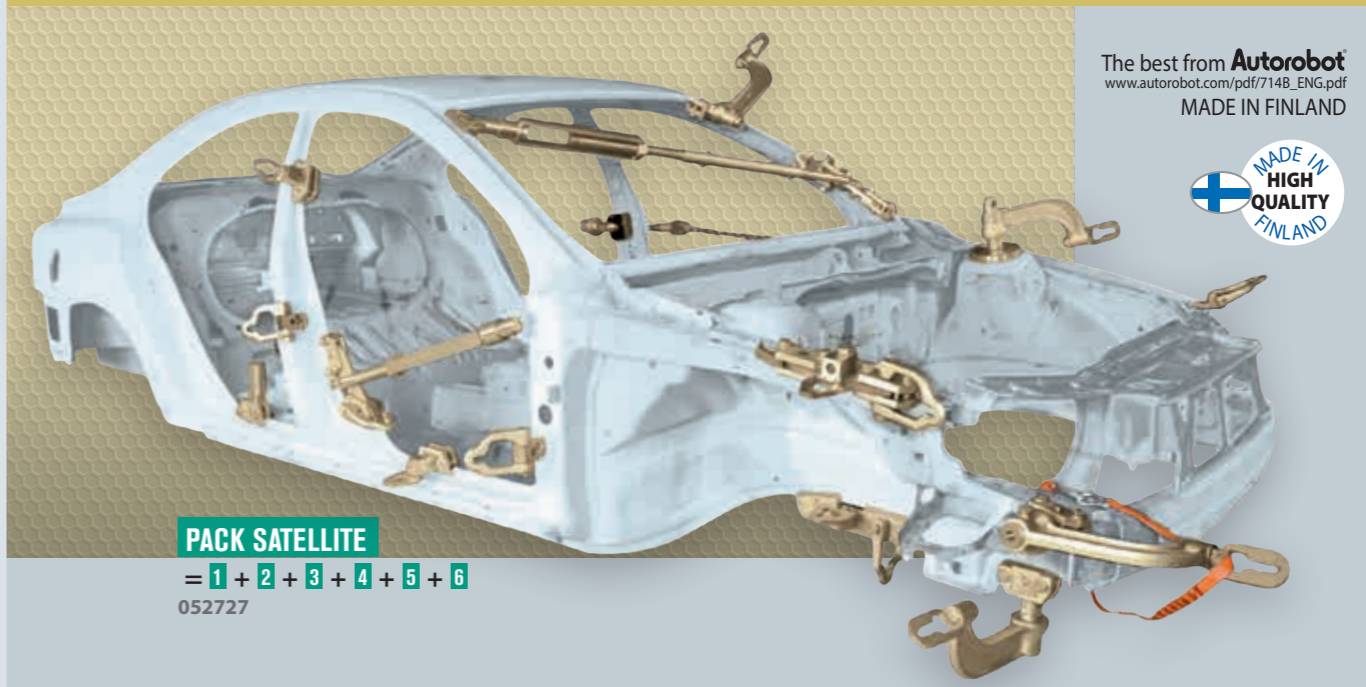

PACK SATELLITE
= 1 + 2 + 3 + 4 + 5 + 6
052727

<p>1 SATELLITE - Satellite - Satellite Basisbügel-Set 052710</p>		<p>2 KIT MAC PHERSON (A) - Mac Pherson Kit - Befestigungskit-Federbein (McPherson) 052703</p>	
<p>3 BARRE POUR TIRER/POUSSER - Push/Pull Bar - Zug/Druck-Stangenset 052673</p>		<p>4 SATELLITE (B) - Bügelverlängerung 052680</p>	
<p>5 SANGLE DE SÉCURITÉ - Safety Strap - Sicherungsgurt 044036</p>		<p>6 DOUBLE PINCE SATELLITE (C) - Double Clamp Satellite - Satellite Doppelklemme 052697</p>	

PINCE DE TIRAGE MULTI-USAGE
- Versatile pulling clamp
- Multifunktions-Zugklemme



WELDING SHEETS KIT WITH CLAMP
- Kit plaques à souder et pince



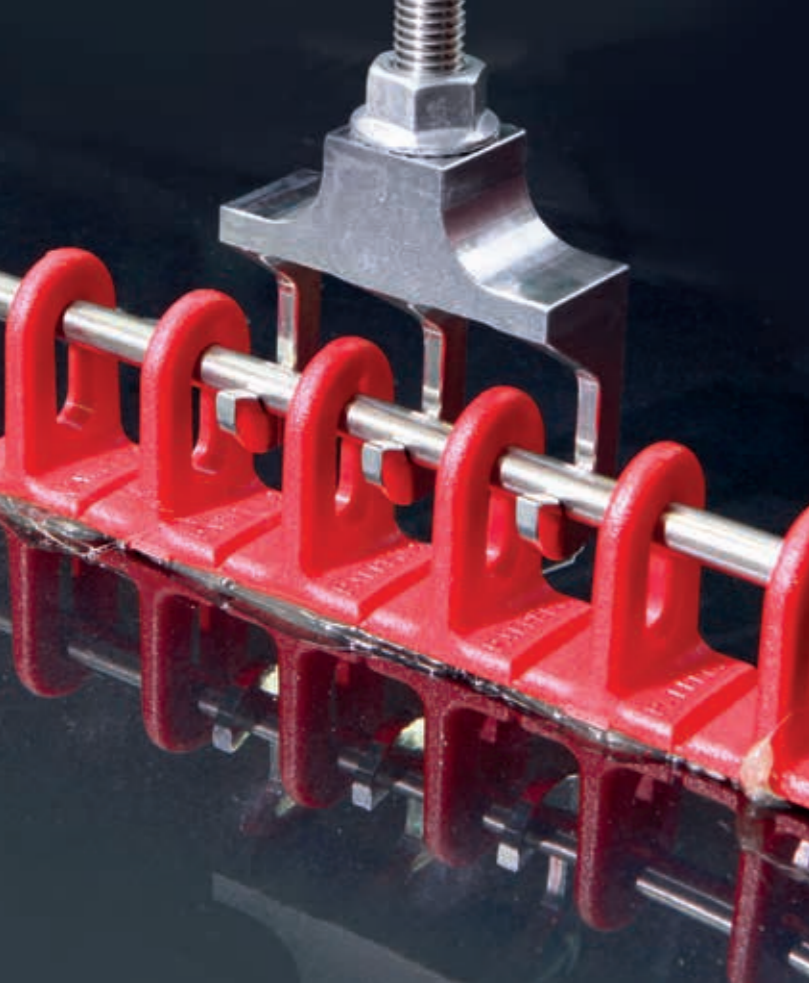

PAINTLESS DENT REPAIR + GLUE PULLING REPAIR

DENT PULLING INDUCTOR

- Inducteur débosselage - Dellenmatrix

GYS
DUCTION
AUTO + Dent pulling
inductor
054776

= GYS
DUCTION AUTO
DENT REPAIR
054981



Youtube



Licensed by
BETAG.Innovation

🔌	🔌	⚡	Freq.	INTEGRATED TECHNOLOGY	❄️	Cable (m)	📦	📏
50 Hz	A	W	kHz	PFC	FV	Liquid Cooling	Inductor	LxWxH cm / kg
230V, 1~	16	2 400	35+120	▪	▪	—	2 2.5	52 x 30 x 37 / 9.4 37 x 21 x 37 / 7.5

DENT PULLING INDUCTOR

- Inspection carrosserie - Ausbeul Induktor

Planche flexible pour inspection de la carrosserie - Ausbeul-Matrix
Ø 800 mm
059122

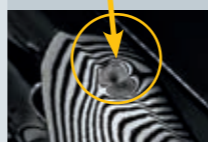

OPTION
Freezer spray
- Spray refroidisseur
-50 °C
400 ml
(x 12)
048898

PAINTLESS DENT REPAIR MAGNETIC KIT

- Kit magnétique de débosselage sans peinture
- Magnetisches Ausbeul-Kit

053168

EXELTOOLS



1010 mm - 40"

705 mm - 28"

610 mm - 24"

510 mm - 20"

DENT PULLING KIT (PAINTLESS)

- Kit débosselage sans peinture - Dellenausbeulhebel-Set

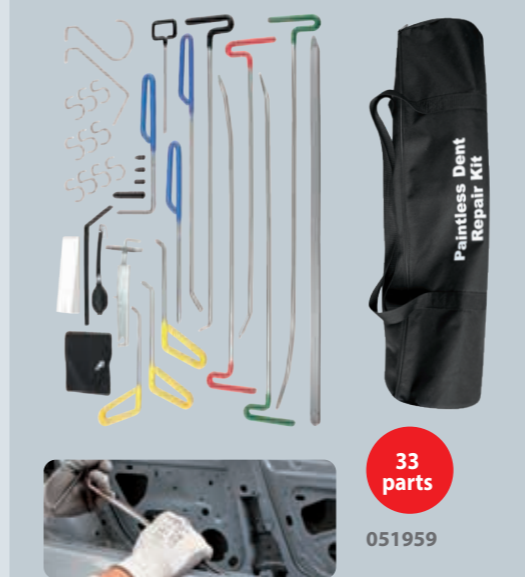

33 parts

051959

AIR CUSHION KIT

- Kit coussins gonflables - Luftpolster-Spreizkissen-Satz



051942

PAINTLESS DENT REPAIR LAMPS

- Lampes de débosselage
- Ausbeullampe

ULTRA LIGHT
CARBON X40 PW
053175

EXELTOOLS

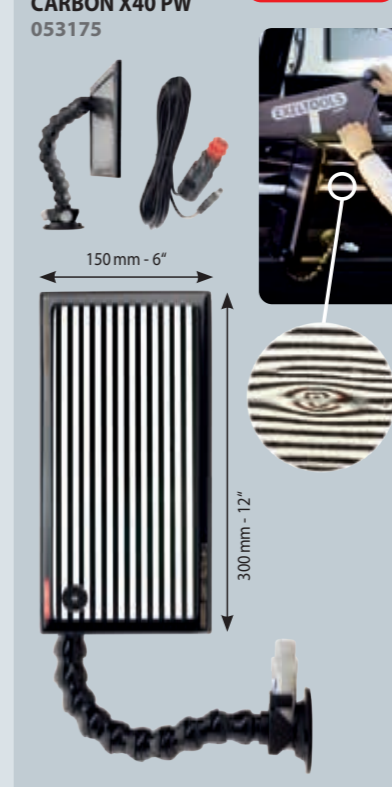

150 mm - 6"

300 mm - 12"

PAINTLESS DENT REPAIR LAMPS

- Lampes de débosselage
- Ausbeullampe

083936

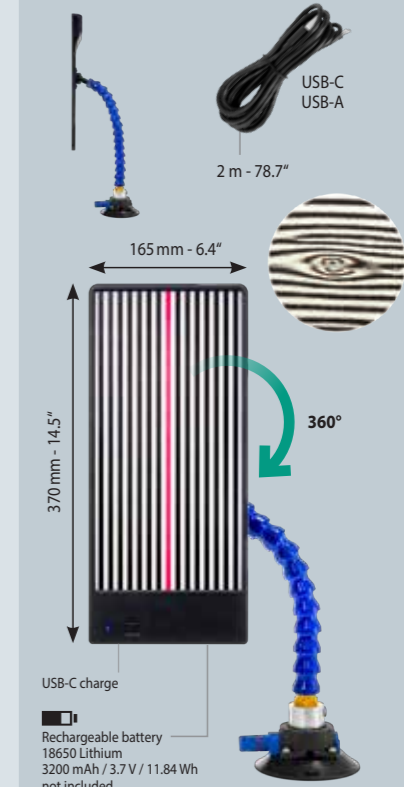

USB-C
USB-A

2 m - 78.7"

165 mm - 6.4"

370 mm - 14.5"

360°

USB-C charge

Rechargeable battery
18650 Lithium
3200 mAh / 3.7 V / 11.84 Wh
not included

SET OF 6 PENCIL PUNCHES

- Kit de 6 coins de frappe - Beulenstemmer-Satz mit 6 Tefloneinsätzen

052888

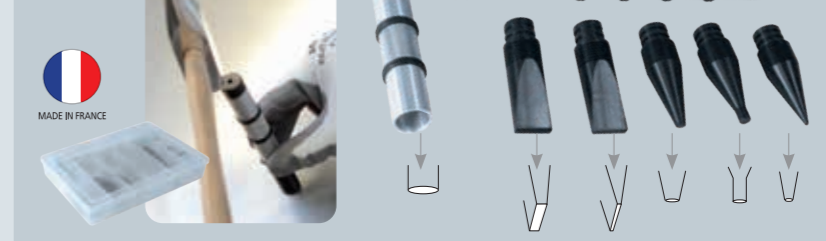

PNEUMATIC INERTIA HAMMER

- Marteau inertie pneumatique - Unterdruck-Schlaghammer

051904

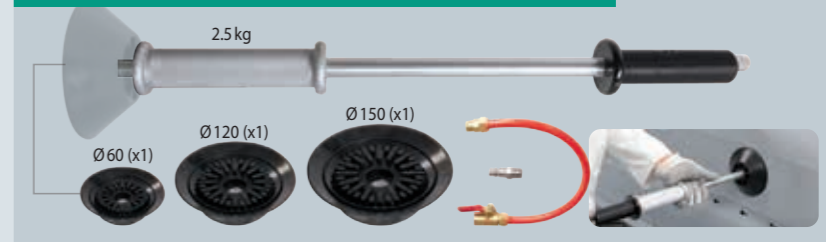

2.5 kg

Ø 60 (x1)

Ø 120 (x1)

Ø 150 (x1)

PUMP AIR SUCTION SLIDE HAMMER

- Marteau à inertie à ventouses (pompage manuel) - Man. Unterdruck-Schlaghammer

1,1 kg

048683



Ø 75 (x1)

Ø 100 (x1)

Ø 125 (x1)



PDR: Paintless Dent Repair
- Débosselage rapide et sans peinture
- Lackschadenfreies Ausbeulen

PAINTLESS DENT REPAIR

GLUE PULLER PRO (Acier/Alu • Steel/Alu)



Glue Puller PRO
058699

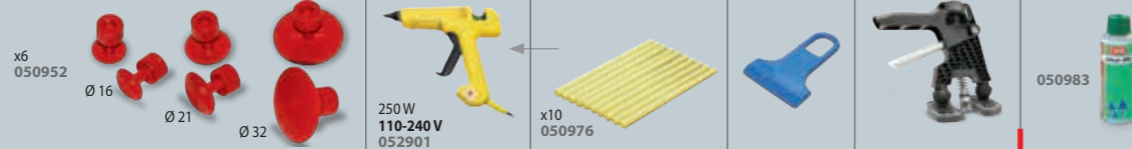

Glue Puller PRO EXPORT
230 V 059160

BARRETTES ANNEAUX PLASTIQUE - Plastic Multipads Ösen-Klebe pads

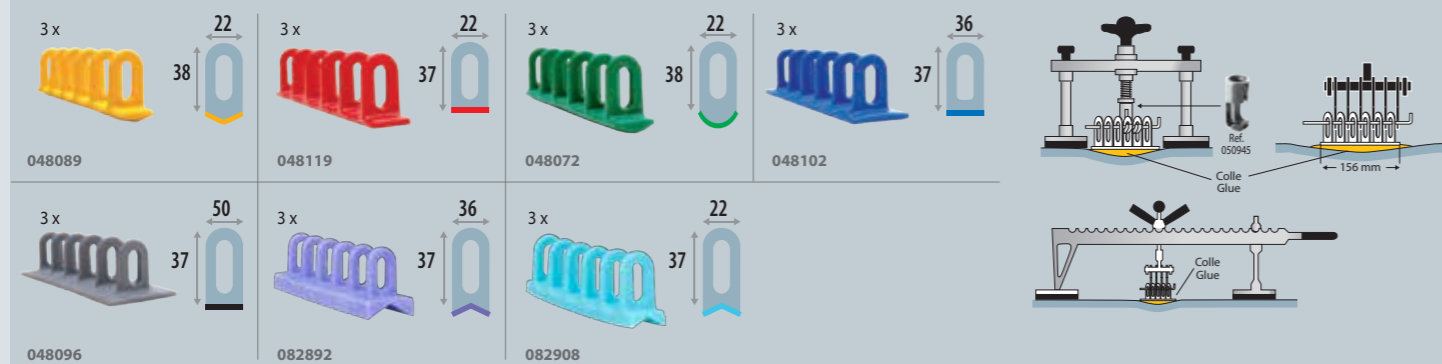

OPTIONS

Pulling handle 3 claws - Poignée de tirage 3 dents - Handzugkralle 3-fach
057326



Slide hammer 380 g
- Marteau à inertie 380 g
- Gleithammer 380 g

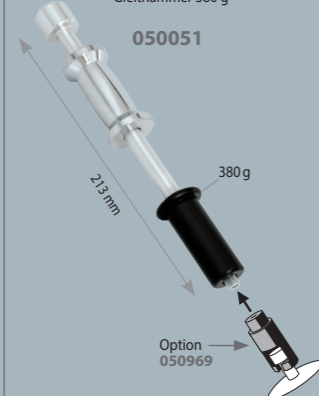

Slide hammer 500 g
- Marteau à inertie 500 g
- Gleithammer 500 g

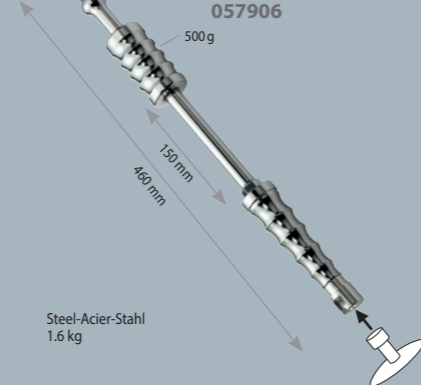

Set of 2 knives to cut glued reinforcements
- Jeu de 2 couteaux pour découpe de renforts colles
- 2-er Set Messer zur Klebepadentfernung



Workstation 054233	Set of pencil punches with 6 teflon tips 052888	Infrared thermometer 079922 Heat Gun 066311	Levelling bar 050693 6 Gripping multihook head 049734	3 Lifting rods 150/300/500 mm 050792	Set of 3 conical plastic multipads 048096 048072 048089 048119 048102	Slide hammer 057906	Set of 6 glue tips 050952	Glue Puller PRO 058699	Glue Puller PRO Export 059160	33PC Paintless dent repair kit 051959 PDR Light ultra light carbon X40PW 053175	Mini puller 050921 Aluminium clamp 2 050945
--------------------	---	--	--	--------------------------------------	---	---------------------	---------------------------	------------------------	-------------------------------	--	--

GYSMART GLUE PULLING KIT 076051					✓						
GYSMART GLUE PULLING KIT EXPORT 076105				✓					✓		
GYSMART GLUE PULLING KIT PLUS 076082					✓						✓
GYSMART GLUE PULLING KIT PLUS EXPORT 076129				✓						✓	



GPR: Glue Pulling Repair
- Débosselage par colle
- Lackschadenfreies Ausbeulen

GLUE PULLING REPAIR



GPR I-BAR MINI



080324



GPR FLEXIBLE TABS

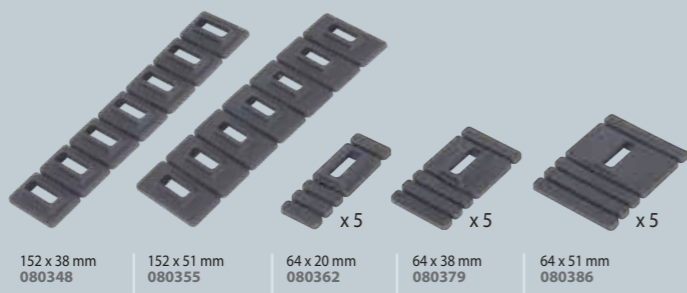

GPR FLAT TABS



GPR 3D TABS



GPR 3D CURVE TABS

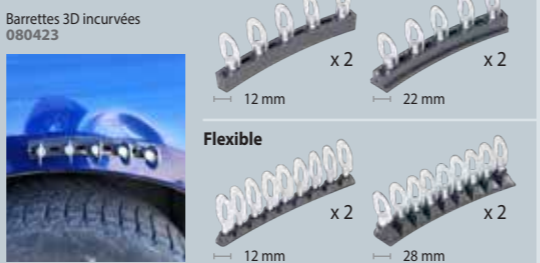

GPR UNIVERSAL TABS

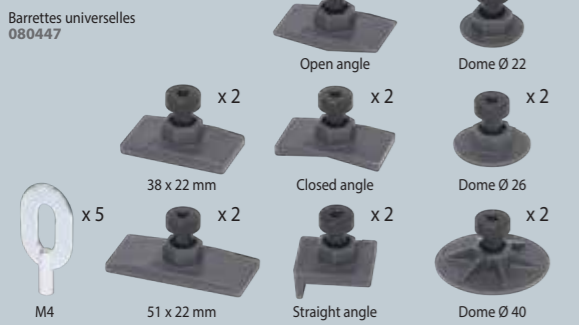

GPR FOLD TABS

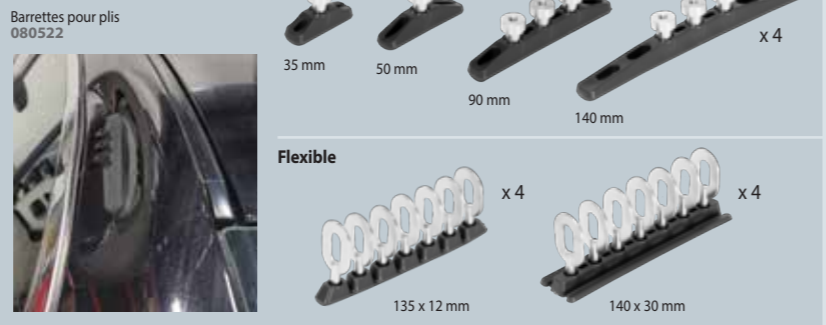

GPR HAIL IMPACT TABS



GPR BAR TABS

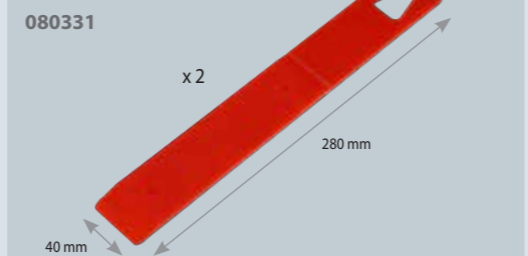

GLUE GUN 400W - Pistolet à colle chaude 400W



GPR PRO KIT



1	GPR I-bar mini	51 mm	x 1
GPR Flexible tabs			
2	64 x 20 mm		x 1
	64 x 38 mm		x 1
	64 x 51 mm		x 1
GPR Long tabs			
3	152 x 38 mm		x 1
	152 x 51 mm		x 1
GPR Plastic hooks			
4			x 10
GPR Bar tab			
5			x 1
GPR 3D tabs			
6	12 mm		x 1
	22 mm		x 1
GPR 3D curved tabs			
7	51 x 38 mm		x 1
	101 x 38 mm		x 1
GPR M4 steel hooks			
8			x 5
GPR Universal tabs			
	Flat 38 x 22 mm		x 1
	Flat 51 x 22 mm		x 1
9	Open angle 38 x 22 mm		x 1
	Closed angle 38 x 22 mm		x 1
	Straight angle 27 x 22 mm		x 1
	Dome Ø 22 mm		x 1
	Dome Ø 26 mm		x 1
	Dome Ø 40 mm		x 1
GPR Flat tabs			
	Ø 13 mm		x 1
	Ø 23 mm		x 1
10	Ø 27 mm		x 1
	Ø 32 mm		x 1
	Ø 38 mm		x 1
	Ø 52 mm		x 1
GPR Bars for folds			
	35 mm		x 1
	50 mm		x 1
	90 mm		x 1
	140 mm		x 1
	Flexible 135 mm		x 1
	140 x 30 mm		x 1
12	GPR Glue sticks		x 10



Isopropyl alcohol
99.9% + spray - Alcool isopropyloque 99.9% + vaporisateur 082236

1 L 600 ml

Heat gun - Décapeur thermique 066311

Digital display - Affichage numérique
I: 100/300°C (450 W)
II: 300/650°C (1500 W)
Air flow: 450 l/min

Gas hot air gun
- Pistolet à air chaud autonome à gaz 060777

Gas included - Bouteille incluse

Blow torch - Lampe à souder 052741

Gas not included - Bouteille non incluse

Novacet +
Butane/Propane/Propylène 040441

HIGH QUALITY
380 ml (220 g)

Infrared thermometer
- Thermomètre infrarouge 079922

Adjustable emissivity: 0.10-1.00
-50~+600°C
-58~+1112°F

Set of 6 pencil punches
- Kit de 6 coins de frappe 052888

(p. 47)

3 plastic wedges
- 3 cales plastiques 051294

Lifting rod 180 mm
- Tige de tirage 180 mm 082915

Pulling hand 3 claws
- Poignée de tirage 3 dents 057326

(p. 48)

Slide hammer 500g
- Marteau à inertie 500g 057906

(p. 48)

Slide hammer 1.7kg
- Marteau à inertie 1,7kg 051201

(p. 10)

Glue Lifter
057364

included 061392
(p. 48)

Arc Puller Premium
065161

included Alu 3 065161
(p. 19)

Arc Puller Premium Pro
072572

included Alu 4 065185
option Steel M14 079830
(p. 19)

Premium Pro Levelling bar
900 mm 071643

(p. 22)

Airfix Draw Aligner
077379

(p. 39)



RESISTANCE SPOT WELDING

RANGES 54

PRESENT MACHINES

PORTASPOT / 100 R.CX / B.P.LX	56
BP GENIUS	58
PTI-S7 / PTI PREMIUM PRO	60
PTI GENIUS	62

NEW MACHINES WITH COLOUR SCREEN

PTI NEO	64
PTI MASTER / PTI EXPERT	66

ARMS & CONSUMABLES

G ARMS	68
ACCESSORIES & CONSUMABLES	69
X ARMS / C ARMS	70

CAR MANUFACTURER REQUIREMENTS

EXIGENCES CONSTRUCTEUR - ANFORDERUNGEN DES AUTOMOBILHERSTELLERS
- REQUISITI DEL PRODUTTORE DI AUTOMOBILI

An example of new generation car body
• Exemple de carrosserie nouvelle génération
• Beispiel einer Karosserie der neuen Generation
• Esempio di carrozzeria di nuova generazione

- HSS - HLE
- Bore - Boron
- VHSS - THLE
- Aluminium
- UHSS - UHLE



MIG/MAG PLUG WELDING - Bouchonnage MIG/MAG

VS RESISTANCE SPOT WELDING - Soudure par résistance

Non-compliant with car manufacturer requirements
- Non conforme aux exigences constructeur

Same mechanical resistance as original
- Même résistance mécanique qu'un point d'origine

INVERTER machine

MANUFACTURER APPROVALS / COMPLIANCE

HOMOLOGATIONS PRODUITS - PRODUKT HOMOLOGATIONEN - PRODOTTI APPROVATI



Machine Model	Volkswagen Group	Jeep	Mercedes	smart	Volvo	BMW	Alfa Romeo	Ford	GM	Hyundai	Kia	Land Rover	Nissan	Peugeot	Renault	Seat	Tata	Vauxhall	Volvo	Other	
DENT PULLER																					
GYSPT 26.02/27.02																					
GYSPT 34.02/04, 36.02/04, 39.02/04, PRO230/400, EXPERT 200/230/400	•	•	•	•	•	•	•	•	•	•	•	•	•	•	•	•	•	•	•	•	•
Workstations	•	•	•	•	•	•	•	•	•	•	•	•	•	•	•	•	•	•	•	•	•
GYSPT ALU FV	•	•	•	•	•	•	•	•	•	•	•	•	•	•	•	•	•	•	•	•	•
GYSPT ARCPULL 200	•	•	•	•	•	•	•	•	•	•	•	•	•	•	•	•	•	•	•	•	•
RESISTANCE SPOT WELDER																					
GYSPT BP-LX	•	•	•	•	•	•	•	•	•	•	•	•	•	•	•	•	•	•	•	•	•
GYSPT BP GENIUS	•	•	•	•	•	•	•	•	•	•	•	•	•	•	•	•	•	•	•	•	•
GYSPT PTI-s7	•	•	•	•	•	•	•	•	•	•	•	•	•	•	•	•	•	•	•	•	•
GYSPT PTI PREMIUM PRO	•	•	•	•	•	•	•	•	•	•	•	•	•	•	•	•	•	•	•	•	•
GYSPT PTI GENIUS	•	•	•	•	•	•	•	•	•	•	•	•	•	•	•	•	•	•	•	•	•
GYSPT PTI NEO, MASTER	•	•	•	•	•	•	•	•	•	•	•	•	•	•	•	•	•	•	•	•	•
GYSPT PTI EXPERT	•	•	•	•	•	•	•	•	•	•	•	•	•	•	•	•	•	•	•	•	•
VAS 821 101 - Spot Welder	•	•	•	•	•	•	•	•	•	•	•	•	•	•	•	•	•	•	•	•	•
RIVE TING																					
GYSPRESS																					
E1 GYS AUTO	•	•	•	•	•	•	•	•	•	•	•	•	•	•	•	•	•	•	•	•	•
E2, E3 GYS AUTO	•	•	•	•	•	•	•	•	•	•	•	•	•	•	•	•	•	•	•	•	•
P1, P2, P3 GYS AUTO	•	•	•	•	•	•	•	•	•	•	•	•	•	•	•	•	•	•	•	•	•
MIG / MAG																					
AUTOPULSE 220-M1	•	•	•	•	•	•	•	•	•	•	•	•	•	•	•	•	•	•	•	•	•
AUTOPULSE 220-M2	•	•	•	•	•	•	•	•	•	•	•	•	•	•	•	•	•	•	•	•	•
AUTOPULSE 220-M3	•	•	•	•	•	•	•	•	•	•	•	•	•	•	•	•	•	•	•	•	•
AUTOPULSE 320-T1	•	•	•	•	•	•	•	•	•	•	•	•	•	•	•	•	•	•	•	•	•
AUTOPULSE 320-T3	•	•	•	•	•	•	•	•	•	•	•	•	•	•	•	•	•	•	•	•	•
VAS 821 005 - Pulse MIG	•	•	•	•	•	•	•	•	•	•	•	•	•	•	•	•	•	•	•	•	•
VAS 821 00580 023	•	•	•	•	•	•	•	•	•	•	•	•	•	•	•	•	•	•	•	•	•
PLASMA																					
EASYCUT 40	•	•	•	•	•	•	•	•	•	•	•	•	•	•	•	•	•	•	•	•	•
CUTTER K25, K35	•	•	•	•	•	•	•	•	•	•	•	•	•	•	•	•	•	•	•	•	•
EASYCUT 30FV, CUTTER 45CT	•	•	•	•	•	•	•	•	•	•	•	•	•	•	•	•	•	•	•	•	•
GYSDUCTION AUTO	•	•	•	•	•	•	•	•	•	•	•	•	•	•	•	•	•	•	•	•	•



RESISTANCE SPOT WELDING RANGES

Monochrome Screen Generation



	PTI s-7	BP GENIUS	PTI PREMIUM PRO	PTI GENIUS
Machine type - Type de machine	Transformer inside	Cable	Transformer inside	Transformer inside
Arm - Bras	C	G	G	G
Max welding current - Courant de soudage max	14500 A	13000 A	14500 A	14500 A
Max tightening force - Effort de serrage max	550 daN	550 daN	550 daN	550 daN
Clamp weight - Poids de la pince	9.9 kg	6.5 kg	10.3 kg	11.3 kg
Electrode with over-opening - Electrode avec sur-ouverture	—	Pneumatic	—	Pneumatic
Welding max frequency - Cadence max de soudage	10 pts/min	20 pts/min	10 pts/min	20 pts/min
Automatique mode - Mode automatique	•	•	•	•
Cooling system - Système de refroidissement	30 litres	30 litres	30 litres	30 litres
Duty cycle - Facteur de marche	★★★★	★★★★	★★★★	★★★★★
Clamp cable length - Longueur faisceau pince	4 m or 6 m	2.5 m	6 m	6 m
Gyro - Gyro	(Option)	• Ball bearing Gyro	•	• Ball bearing Gyro
Mains cable length - Longueur câble secteur	8 m	8 m	8 m	8 m
Balancing arm - Avec potence	•	•	•	• Electric, adjustable height
Disconnectable clamp - Pince déconnectable	•	—	•	—
Single sided gun - Pistolet monopoint	(Option)	•	(Option)	(Option)
Software update - Mise à jour logicielle	SD card	SD card	SD card	SD card

3.5" Colour Screen Generation



	PTI NEO	PTI MASTER	PTI EXPERT
Machine type - Type de machine	Transformer inside	Transformer inside	Transformer inside
Arm - Bras	G	G	G
Max welding current - Courant de soudage max	13000 A	13000 A	14500 A
Max tightening force - Effort de serrage max	550 daN	550 daN	550 daN
Clamp weight - Poids de la pince	9.7 kg	10.3 kg	11.8 kg
Electrode with over-opening - Electrode avec sur-ouverture	—	Mechanical	Mechanical
Welding max frequency - Cadence max de soudage	10 pts/min	10 pts/min	10 pts/min
Automatique mode - Mode automatique	•	•	•
Cooling system - Système de refroidissement	5 litres	5 litres	30 litres
Duty cycle - Facteur de marche	★★★	★★★	★★★★★
Clamp cable length - Longueur faisceau pince	4 m	4 m	5 m
Gyro - Gyro	—	—	•
Mains cable length - Longueur câble secteur	8 m	8 m	8 m
Balancing arm - Avec potence	—	—	•
Disconnectable clamp - Pince déconnectable	—	—	•
Single sided gun - Pistolet monopoint	(Option)	(Option)	(Option)
Software update - Mise à jour logicielle	USB	USB	USB



PORTASPOT / GYSPOT

RESISTANCE SPOT WELDING

PORTASPOT 230

6 300 A 120daN

Air cooled

230V
022256

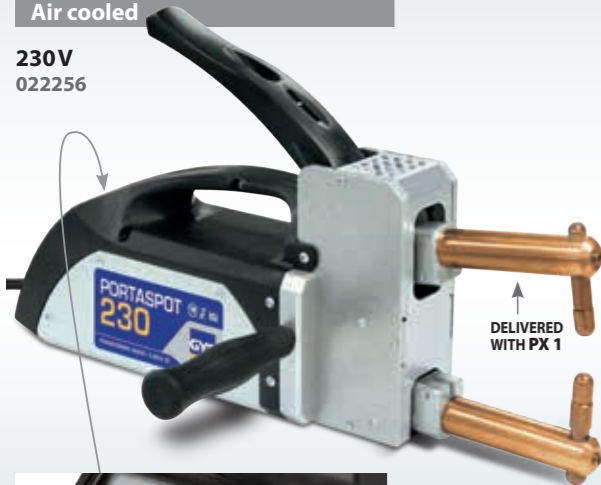

DELIVERED WITH PX 1



ARMS Ø 23 mm

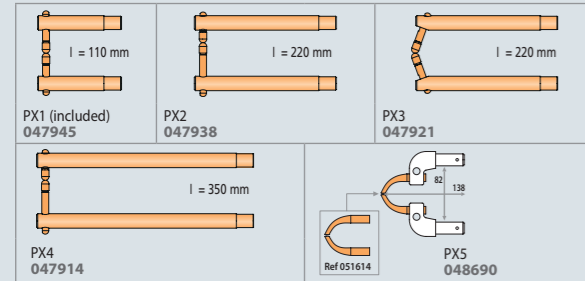

ELECTRODES

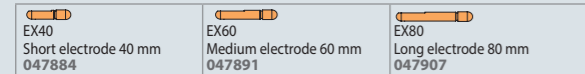

CAPS & ACCESSORIES

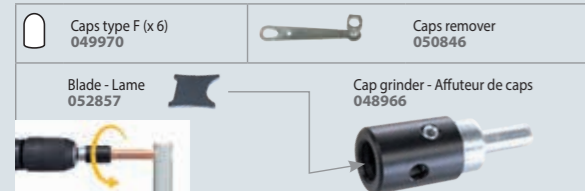

50/60 Hz	A	A	A	mm	V	mm	mm ²	100% CU	LxWxH cm / kg
1 x 230V	16(D)	6 300	8 900	2+2	2.45	2.5	3x2.5 H05VVf	OK	41 x 18 x 22 / 11.3

GYSPOT 100R-CX

10 000 A 550 daN (X) 350 daN (C)

For mild steel, HSS, UHSS

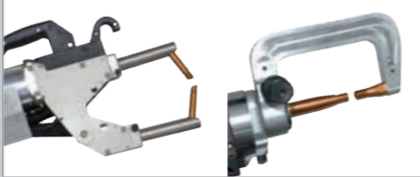

Air cooled

Traceability software
Save spot welding configuration and export data



3 x 400V
022317



OPTIONS 100R-CX

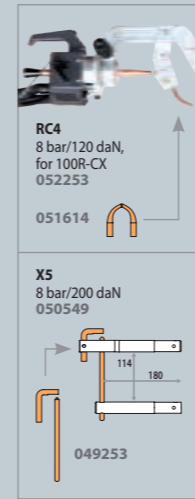

included	
Monopoint/Spot 049291	▪
Inertia hammer 049482 + 049802	▪
Spotter box pro 050075	▪
Top support box	▪
Contact grease 050440	▪
Caps remover 050846	▪
Cable support	× 2
RX1 051034	▪
RX3 051058	▪
RC1 051065	▪
RC2 051072	▪
RC3 051089	▪

OPTIONS

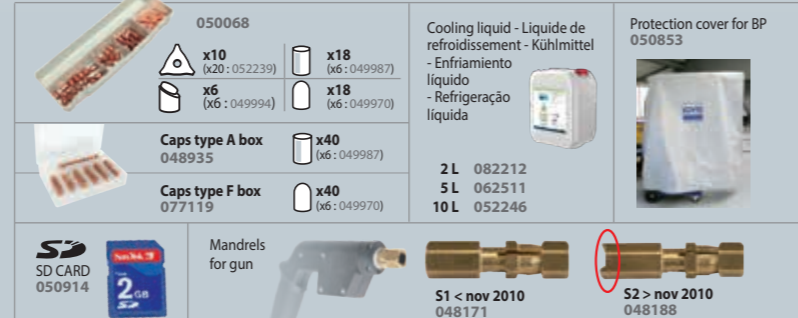

GYSPOT BP-LX

13 000 A 550 daN

For mild steel, HSS, UHSS Boron steel



Liquid cooled

BP BODYPROTECT
Unique electro-magnetic field protection
2019/35/UE by GYS

Traceability software
Save spot welding configuration and export data



019652

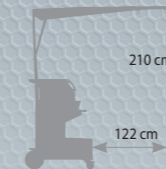

	019652	058804
Gyspot BP-LX	400V	
Monopoint/Spot 049291	▪	▪
Spotter box pro (p.10) 050075	▪	▪
Inertia hammer 049482 + 049802	▪	▪
X1 050501	▪	▪
X4A (x2) + X4B + X4C + X2 020733	▪	▪
Liquid cooling (10l) 052246		▪ (x3)

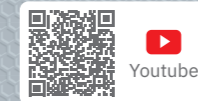

MADE IN FRANCE 62135	50/60 Hz	A D curve	Spots/min (max) ± 2.5+2.5	RMS A	mm	Uo V	Cables				100% CU	LxWxH cm / kg	
							2.5 m, air Ø 200 mm ²	2.5 m, air Ø 200 mm ²	2.5 m, air Ø 150 mm ²	8 m, 4 x 6 H07RNF			
GYSPOT 100R.CX	3 x 400V	32 (22 kVA) 40 (28 kVA) 50 (35 kVA)	2 6 10	10 000	2.5+2.5+2.5	1.5+3	16	2.5 m, air Ø 200 mm ²	2.5 m, air Ø 200 mm ²	2.5 m, air Ø 150 mm ²	8 m, 4 x 6 H07RNF	OK	61 x 79 x 71 / 137
GYSPOT BPLX	3 x 400V	32 (22 kVA) 40 (28 kVA) 50 (35 kVA)	2 6 10	13 000	2.5+2.5+2.5	1.5+3	16	2.5 m, liquid	—	2.5 m, air	8 m, 4 x 6 H07RNF	OK	65 x 80 x 205 / 164.5



57

GYSPOT 100R / BP

AIR / LIQUID COOLED

56



GYSPOT

RESITANCE SPOT WELDING BP GENIUS

G
ARMS



MADE IN FRANCE

G-clamp front
body + protection
078765

**ULTRA LIGHT
& COMPACT**
6.5 kg
(Gyro & G1 included)

550 daN

LIQUID COOLED
REFROIDISSEMENT
LIQUIDE
Ø 10 mm

6.5 kg
(Gyro & G1 included)



Youtube

OPTIONS

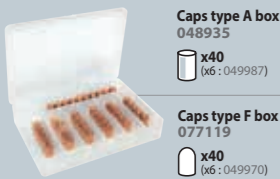

Caps type A box
048935
x40 (x6: 049987)
Caps type F box
077119
x40 (x6: 049970)

x20 (x6: 049987)
x6 (x6: 049970)
x2 (x1: 050617)
073449



Cooling liquid - Liquide
de refroidissement
- Kühlmittel
- Enfriamento líquido
- Refrigeração líquida

2L 082212
5L 062511
10L 052246



Protection
cover
- Housse de
protection
- Schutzhaube
for BP & PTI
050853



10-14 kg
059696

FAST OPEN XL

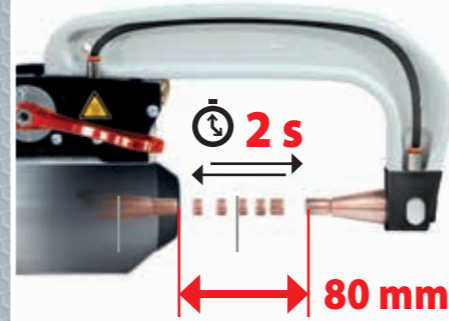

EASY



GYRO INTEGRATED



PERFECT ELECTRICAL CONNECTION



AUTO

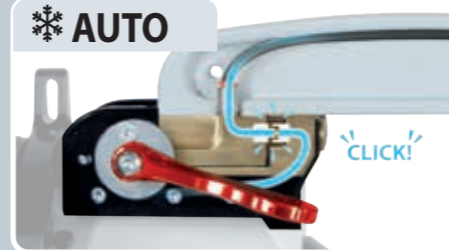

GYSPOT BP GENIUS

13 000 A
550 daN

For mild steel, HSS, UHSS Boron steel

BP BODYPROTECT
Unique electro-magnetic field protection
by GYS

Traceability software
Save spot welding configuration
and export data



	023550	023451	082250
Gyspot BP GENIUS	220V	400V	
Monopoint/Spot 049291	▪	▪	▪
Spotter box pro (p.10) 050075	▪	▪	▪
Inertia hammer 049482 + 049802	▪	▪	▪
Caps remover 050846	▪	▪	▪
Arm support	▪	▪	▪
G1 022768	▪	▪	▪
G2 + G3 + G4 022898	▪	▪	▪
Liquid cooling (10L) 052246	▪	▪	(x3)
Caps type A box 048935	▪	▪	▪
Protection cover 050853	▪	▪	▪



59

GYSPOT BP GENIUS

LIQUID COOLED

MADE IN FRANCE 62135	50/60 Hz	RMS A	-AM- A D curve	Spots max 2.5+2.5 mm	Uo V	mm			Cables			100 % CU	cm	kg														
						↕	↔	↗	↖	↔	↔																	
GYSPOT BP GENIUS 400V	3 x 400V	13 000	32 (22 kVA) 40 (28 kVA) 50 (35 kVA)	2 6 10	16	2.5+2.5+2.5	1.5+3	2.5 m, Ø 200 mm ² , Liquid	2.5 m, Ø 150 mm ² air	8 m 4x6 mm ² H07RN-F	OK	65 x 80 x 205	171															
														GYSPOT BP GENIUS 220V	3 x	200V 208V 230V 240V	10 500 11 000 12 000 12 500	60 (21-25 kVA) 80 (28-33 kVA) 100 (35-41 kVA)	2 6 10	15 15.5 17 18	2.5+2.5+2.5	1.5+3	2.5 m, Ø 200 mm ² , Liquid	2.5 m, Ø 150 mm ² air	8 m 4x6AWG (500V)	OK	65 x 80 x 205	178



GYSPOT

RESISTANCE SPOT WELDING

GYSPOT PTI-s7

14 500 A
550 daN

For mild steel, HSS, UHSS Boron steel

- FUSE 20 A
- Double pressure
- Ø 10 mm
- 9.9 kg (included C1)

TRANSFORMER INSIDE

Liquid cooled

Traceability software
Save spot welding configuration and export data

Convert PTI S-7 to Premium Pro
C ARMS G ARMS

Kit Renov PTI Premium Pro

220V
072367

400V
072541

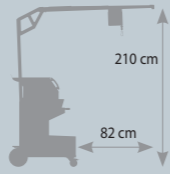

C ARMS



9.9 kg

	220V	400V	
Gyspot PTI-s7	6M 022195	4M 020894	4M 067998
Contact grease 050440	▪	▪	▪
Caps remover 050846	▪	▪	▪
Arm panel	▪	▪	▪
C1 021402	▪	▪	▪
C2 + C3 + C4 060821	▪	▪	▪
C6 022409	▪	▪	▪
Gyro 360° 051720	▪	▪	▪
Complete gun kit 067318	▪	▪	▪
Liquid cooling (10L) 052246	▪	▪	(x3)

OPTIONS

GYRO 360° for PTI S-7
051720

Kit gun for PTI S-7
067318

200 mm²
1.6 m

300 mm²
1 m

Cooling liquid - Liquide de refroidissement
- Kühlmittel
- Enfriamiento líquido
- Refrigeração líquida

2 L 082212
5 L 062511
10 L 052246

Protection cover
- Housses de protection
- Schutzhaube

for BP & PTI
050853

10-14 kg
059696

MADE IN FRANCE 62135	50/60 Hz	RMS A	S RMS A D curve	Spots/min (max)	U _o		mm			Cables			cm	kg
					V	V	↖	↗	↘	↙	↘	↙		
GYSPOT PTI-s7	3 x 400 V	14 500	20 (14 kVA)	10	7.3	2.5+2.5+2.5	1.5 + 3	4 m, liquid or 6 m, liquid	OPTION 067318 : 1.6 m, Ø 200 mm ²	8 m, 4x4 mm ² H07RNF	65 x 80 x 230	105.3		
GYSPOT PTI-s7 220 V	3 x	200 V 12 500	208 V 13 000	40 (14-16 kVA)	10	6.5	2.5+2.5+2.5	1.5 + 3	4 m, liquid or 6 m, liquid	OPTION 067318 : 1.6 m, Ø 200 mm ²	8 m, 4xAWG8 (500W)	65 x 80 x 230	115.7	
230 V 14 500		7.4												
240 V 14 500		7.7												

GYSPOT PTI PREMIUM PRO

14 500 A
550 daN

For mild steel, HSS, UHSS Boron steel

- FUSE 25 A
- Double pressure
- Ø 10 mm
- 10.3 kg (included G1)

TRANSFORMER INSIDE

Liquid cooled

Traceability software
Save spot welding configuration and export data

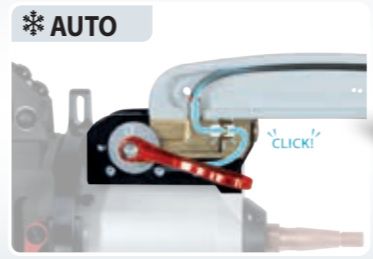

OPTIONS

Kit gun for PTI Premium Pro
067226

300 mm²
1.8 m

300 mm²
1 m

G11
for PTI Premium Pro
071766

25 mm max
120 mm

MADE IN FRANCE 62135	50/60 Hz	RMS A	S RMS A D curve	Spots/min (max)	U _o		mm			Cables			cm	kg
					V	V	↖	↗	↘	↙	↘	↙		
GYSPOT PTI PREMIUM PRO 400V	3 x 400 V	14 500	25 (14 kVA)	10	7.4	2.5+2.0+2.0	1.5 + 3.0	6 m, liquid	OPTION 067226 : 1.8 m, Ø 300 mm ²	8 m, 4x4 mm ² H07RNF	65 x 100 x 230	109		
GYSPOT PTI PREMIUM PRO 220V	3 x	200 V 12 500	50 (17-21 kVA)	10	6.5	2.5+2.0+2.0	1.5 + 3.0	6 m, liquid	OPTION 067226 : 1.8 m, Ø 300 mm ²	8 m, 4xAWG8 (500W)	65 x 100 x 230	119		
208 V 13 000		7.4												
230 V 14 500		7.4												
240 V 14 500		7.7												

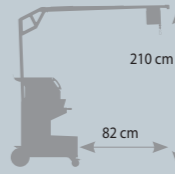

G ARMS



10.3 kg

	220V	400V	
Gyspot PTI Premium Pro	6M 072206	6M 072183	6M 082243
Caps remover 050846	▪	▪	▪
Arm panel	▪	▪	▪
G1 022768	▪	▪	▪
G2 + G3 + G4 022898	▪	▪	▪
Liquid cooling (10L) 052246	▪	▪	(x3)
Caps type A box 048935	▪	▪	▪
Protection cover 050853	▪	▪	▪

GYSPOT PTI INVERTER





GYSPOT

RESISTANCE SPOT WELDING PTI GENIUS



MADE IN FRANCE

550 daN

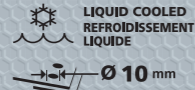

11.3 kg
(Gyro & G1 included)

FAST OPEN XL

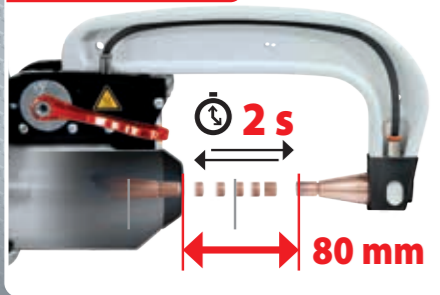

GYRO INTEGRATED

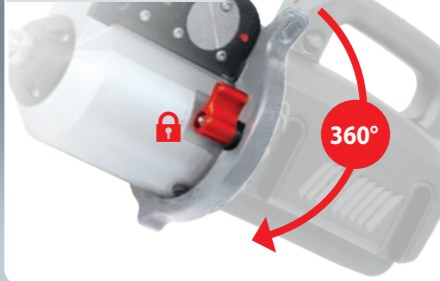

PERFECT ELECTRICAL CONNECTION

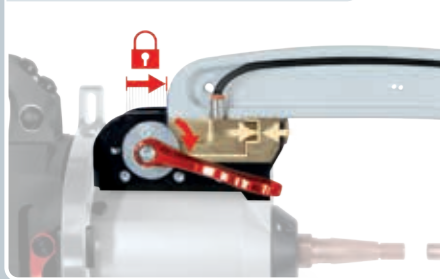

AUTO

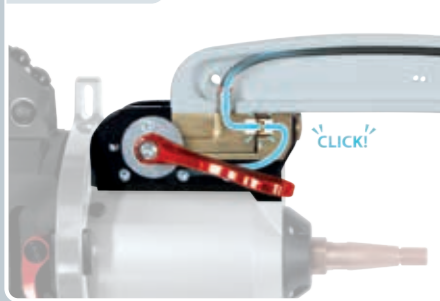

OPTIONS

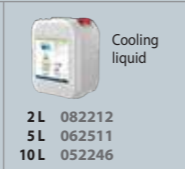

G ARMS

G-clamp front body + protection 078765

TRANSFORMER INSIDE

Control command
- Contrôle de commande

Motorised cable support
- Potence électrique
- Elektrisch verstellbarer Kabelsupport



UPSIDE DOWN POSITION

GYSPOT PTI GENIUS

14 500 A

550 daN

For mild steel, HSS, UHSS **Boron steel**

TRANSFORMER INSIDE

Liquid cooled

Traceability software
Save spot welding configuration and export data

	024878	082267	024854	024892
	400V		220V	480V
Gyspot PTI-GENIUS				
Caps remover 050846	▪	▪	▪	▪
Arm support	▪	▪	▪	▪
G1 022768	▪	▪	▪	▪
G2 + G3 + G4 022898	▪	▪	▪	▪
Liquid cooling (10L) 052246		(x3)		
Caps type A box 048935		▪		
Protection cover 077126		▪		

Ergonomic

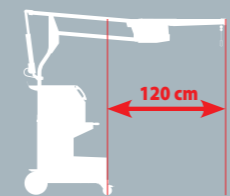

Included Cable support
ULTRA RESISTANT



Control Commande

ELECTRIC MOTOR

Electrode storage
- Rangement pour électrodes

6 m

High stability - Grande stabilité

OPTIONS

Kit gun 067226



MADE IN FRANCE 62135	50/60 Hz	RMS A	-I-AM- A D curve	Spots/min (max)	Uo V	mm		Cables		cm	kg		
						↕	↔	↕	↔				
GYSPOT PTI GENIUS 400V	3 x 400V	14 500	25 (17 kVA)	20	7	2.5+2.5+2.5	1,5 + 3	6 m, Liquid	8 m 4x4 mm² H07RN-F	71 x 90 x 200	127.7		
												200	12 500
												208	13 000
												230	14 500
GYSPOT PTI GENIUS 220 V	3 x 230V	14 500	50 (17-21 kVA)	20	7.3	2.5+2.5+2.5	1,5 + 3	6 m, Liquid	8 m 4xAWG8 (500W)	71 x 90 x 200	136.2		
												240	14 500
												7.9	
GYSPOT PTI GENIUS 480V	3 x 480V	14 500	20 (17 kVA)	20	7	2.5+2.5+2.5	1,5 + 3	6 m, Liquid	8 m 4xAWG12 (500W)	71 x 90 x 200	128.7		

GYSPOT PTI GENIUS

LIQUID COOLED



RESISTANCE SPOT WELDING PTI NEO

NEW



MADE IN FRANCE

Manual Mode

Direct entry of welding current, time and pressure -
Entrée directe du courant et temps de soudage et de la pression

3.5" colour screen
Easy navigation interface



Traceability software
Save spot welding configuration and export data



Automatic Mode

Automatic detection of the welding parameters
- Détection automatique des paramètres de soudage



Synergic Mode

User defined welding parameters
- Programmation par l'utilisateur



Car Manufacturer Mode

Specific Car Manufacturer pre-programmed welding parameters
- Points de soudure constructeur préprogrammés



G ARMS

EASY OPENING

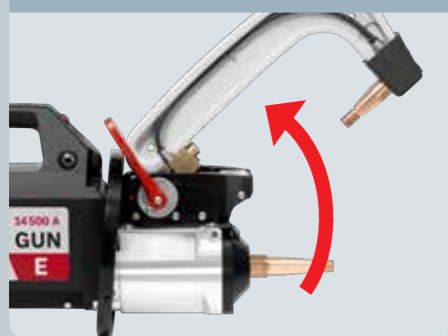

PERFECT ELECTRICAL CONNECTION



AUTOMATIC HYDRAULIC CONNECTION



OPTIONS

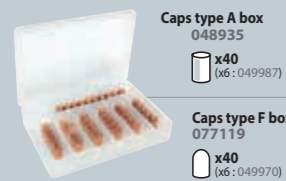

Caps type A box
048935
x40 (x6: 049987)
x6 (x6: 049970)
x2 (x1: 050617)
073449



EASY USB UPDATE
USB key 16 Gb
062344

Cooling liquid - Liquide de refroidissement
- Kühlmittel
- Enfriamiento líquido
- Refrigeração líquida
2L 082212
5L 062511
10L 052246



Protection cover
- Housse de protection
- Schutzhaube
062733



GYSPOT PTI NEO

13000 A
550 daN

For mild steel, HSS, UHSS Boron steel

TRANSFORMER INSIDE

Liquid cooled : 5 litres

Automatic Mode

Automatic detection of the welding parameters

3.5" colour screen

Easy navigation interface

Traceability software

Save spot welding configuration and export data

	024779	084834	077362	084841
Gyspot PTI-NEO	400V		208-240V	
Caps remover 050846	■	■	■	■
G1 022768	■	■	■	■
G2 + G4	■	■	■	■
	ALL IN 1 BOX	ALL IN 1 BOX	ALL IN 1 BOX	ALL IN 1 BOX

78.5 x 58.5 x 64 cm 6 units/palette

G arms storage



G1, G2, G3 storage

OPTION

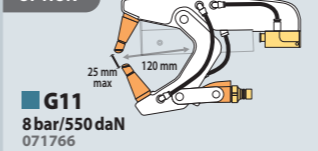

G11 8 bar/550 daN 071766

G ARMS



9.7 kg
VERY LIGHT

OPTION

QUICK FIX Single sided gun
- Kit Pistolet monopoint
082823



EASY CONNECTION



HSS
UHSS
Boron

NEW
05/2024



4 m

LIGHT TROLLEY

LIQUID COOLING
5 Litres

MADE IN FRANCE 62135	50/60 Hz	RMS A	TAM A D curve	Spots/min (max)	Uo V	mm		Cables				cm	kg		
						mm	mm	mm	mm	mm	mm				
GYSPOT PTI NEO 400V	3 x 400V	13 000	20	10	7.7	2.5+2.0+2.0	1.5+3.0	4 m, Liquid	1.8 m, Ø 300 mm ²	1 m, Ø 300 mm ²	8 m 4x4 mm ² HOT8NF	63 x 76 x 127	57		
														200V	10 900
														208V	11 300
														230V	12 500
GYSPOT PTI NEO 208-240V	3 x	13 000	30	10	6.7 6.9 7.7 8	2.5+2.0+2.0	1.5+3.0	4 m, Liquid	1.8 m, Ø 300 mm ²	1 m, Ø 300 mm ²	8 m 4xAWG8 (SOOW)	63 x 76 x 127	62		
														240V	13 000



GYSPOT

RESISTANCE SPOT WELDING

PTI MASTER PTI EXPERT



MADE IN FRANCE

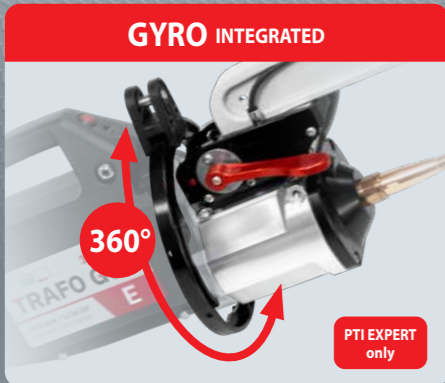
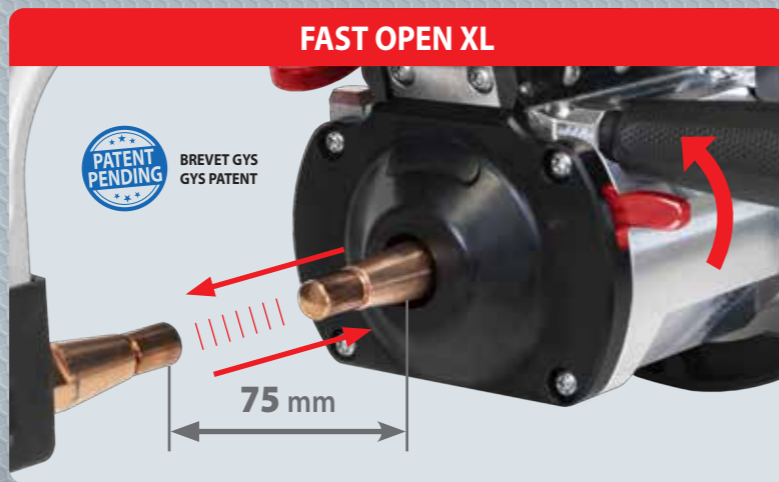

TRANSFORMER INSIDE

MASTER 10.3 kg
(G1 included)

EXPERT 11.8 kg
(Gyro + G1 included)

LIQUID COOLED
Refróidissement liquide

OPTIONS

G-clamp front body + protection 078765



QUICK FIX Single sided gun - Kit Pistolet monopoint 082823

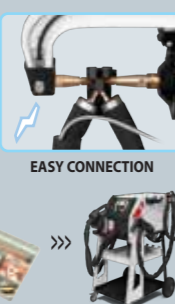

Protection cover for PTI MASTER 062733



Protection cover for PTI EXPERT 050853



10-14 kg 059696

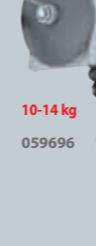

TRANSFORMER INSIDE
For mild steel, HSS, UHSS
Boron steel

Automatic Mode

3.5" colour screen

Traceability software

GYSPOT PTI MASTER

13000 A
550 daN

Liquid cooled : 5 litres

GYSPOT PTI EXPERT

14500 A
550 daN

Liquid cooled : 30 litres

GYSPOT PTI MASTER 400V

13 000 A 400V • 3 phase

083264

GYSPOT PTI EXPERT 400V

14 500 A 400V • 3 phase

083943

GYSPOT PTI MASTER 208-240V

13 000 A 208-240V • 3 phase

083257

GYSPOT PTI EXPERT 208-240V

14 500 A 208-240V • 3 phase

083950



Country	Voltage	RMS A	A D curve	Spots/min (max)	Uo V	mm		Cables				cm	kg	
						mm	mm	(option)	(option)	(option)	(option)			
MADE IN FRANCE	3 x 400 V	13 000	20	10	7.7	2.5+2.0+2.0	1.5 + 3.0	4 m, Liquid	1.8 m, Ø 300 mm ²	1 m, Ø 300 mm ²	8 m, 4x4 mm ² H07RNF	63 x 76 x 127	58	
	3 x	200 V	10 900	30	10	6.7	2.5+2.0+2.0	1.5 + 3.0	4 m, Liquid	1.8 m, Ø 300 mm ²	1 m, Ø 300 mm ²	8 m, 4xAWG8 (500V)	63 x 76 x 127	63
		208 V	11 300			6.9								
		230 V	12 500			7.7								
240 V		13 000	8											
Japan, USA, Brazil, Italy	3 x 400 V	14 500	25	10	7.4	2.5+2.0+2.0	1.5 + 3.0	5 m, Liquid	1.8 m, Ø 300 mm ²	1 m, Ø 300 mm ²	8 m, 4x4 mm ² H07RNF	65 x 100 x 230	109	
	3 x	200 V	12 500	50	10	6.5	2.5+2.0+2.0	1.5 + 3.0	5 m, Liquid	1.8 m, Ø 300 mm ²	1 m, Ø 300 mm ²	8 m, 4xAWG8 (500V)	65 x 100 x 230	119
		208 V	13 000			6.7								
		230 V	14 500			7.4								
240 V		14 500	7.7											

GYSPOT
67
PTI MASTER / EXPERT
LIQUID COOLED

FOR GYSPOT BP GENIUS, PTI PREMIUM PRO & PTI GENIUS

G Arms - Caps Ø13 mm

Bras isolés - Isolated arms - Isolierte Bügel

G2 8 bar/300 daN 022775

G6 8 bar/550 daN 022812

G7 4 bar/150 daN 022829

G11 8 bar/550 daN 022768
for PTI PREMIUM PRO, NEO, MASTER & EXPERT 071766

Kit de maintenance connecteurs pince G - Connectors maintenance kit for G clamp 067295

G arms protections 067288

G4 8 bar/550 daN 022799
Option for G4

G5 8 bar/550 daN 022805
Option for G5

G8 8 bar/550 daN 022836
Option for G8

G1 8 bar/550 daN 022768
Option for G1 & G3

G3 8 bar/550 daN 022782
Option for G3

G14 8 bar/550 daN 080942

G4-SA (Small Access) 064478
(for arms < 01/2021)

G5/G10-SA (Small Access) 067660

G8-SA (Small Access) 067677

G1/G3-SA (Small Access) 067653
(for arms > 02/2021)

G10 8 bar/400 daN 067165
Option for G10 & G12

G12 8 bar/300 daN 075238

G5/G10/G12-SA (Small Access) 067660

G X UNIQUE SYSTEM

BREVETÉ / PATENTED n° US 11,618,097

AUTOMATIC WELDING FOR X1, X2 & X6

G9 | 8 bar/550 daN not for PTI PREMIUM PRO

G9 with X1 Included 022881

X1 050501

X2 050518

G9 with X6 Included 072275

X6 050587

Option SD card 050914

Option PCB 97449C

RESISTANCE SPOT WELDING

GENIUS ARMS

G ARMS PANELS

G2 + G3 + G4 022898

G2 + G3 + G5 063297

KIT SMALL ACCESS GENIUS for PTI GENIUS 077072

included SA 073579

+ G1/G3-SA (Small Access) 134

+ G4-SA (Small Access) 156

+ G5/G10/G12-SA (Small Access) 220

+ G8-SA (Small Access) 368

X/C/G CONSUMABLES - Consommables X/C/G

Type A Cor X clamp Ø 13 mm (x6) 049987

Type B Cor X clamp Ø 13 mm / Ø 5 mm (x6) 055506

Type D Cor X clamp Ø 13 mm (x10) 058507

TYPE F For single sided gun Ø 13 mm (x6) 049970

TYPE G Ø 13 mm (x10) 059672

Caps inclinés - Beveled X2, X4C11 arms Ø 13 mm (x6) 049994

Caps type A box 048935 x40

Caps type F box 077119 x40

Contact grease Graise contact 050440

Caps remover 050846

Anti-corrosion welding primer - Primaire de soudage anti-corrosion 076822

Spot / Monopoint 049291

CAP GRINDER - Affuteur de caps

Lame-Blade 052857

048966

Optimal speed: 400-800 rpm

Youtube

GYRO 360°

for PTI 051720

STEEL SHEET TRACTION BENCH

- Banc de traction arrache tôle - Blech-Zugbank zur Festigkeitsprüfung

052420

052321 (included)

WELD TEST KIT - Valise test soudure HLE / THLE

- Schweißtestkit im Hartschalenkoffer

050433

Barre d'arrache / Traction bar + Acier doux / Mild steel 0.65 (x25) + 1.0 (x25) + Acier HSLA 360 - HLE 0.8 (x25) + 1.5 (x25) + Acier DP600 - THLE/UHLE 1.0 (x25) + Acier FB560 - THLE/UHLE 2.5 (x25)

ANTI-ARC PROTECTION 12V

- Protection anti-arc 12 V - Lichtbogenschutz 12V - Protección anti-arco 12V

041318

PROTECTION COVER

- Housses de protection - Schutzhaube

for BP & PTI 050853

for PTI GENIUS 077126

SHEETS SET

- Échantillons de tôles

Acier standard / Standard steel 0.8 (x65) + 1 (x55) + 1.5 (x35) + 2 (x25) + Alu 1 (x45) + 1.5 (x30) + 2 (x20) 055841

ELECTRODE FORCE SENSOR

- Capteur d'effort

052314

TANK DRAINING KIT - Kit de purge réservoir - Kit zur Tankentleerung

058286

for GYSPOT PTI-s7

SD MEMORY CARD

- Carte mémoire SD

SD CARD 050914

KIT WIFI

for Gyspot Inverter PTI GENIUS 070691

COOLING LIQUID

- Liquide de refroidissement - Kühlmittel - Enfriamiento líquido - Refrigeração líquida

2 L 082212

5 L 062511

10 L 052246

RESISTANCE SPOT WELDING

ACCESSORIES

FOR GYSPOT 32D-X, 100R-CX, BP-LX

550 daN

6,5 kg including X1

- DOUBLE PRESSURE
- LIQUID COOLED / REFRIGÉRATION LIQUIDE
- Ø 10 mm

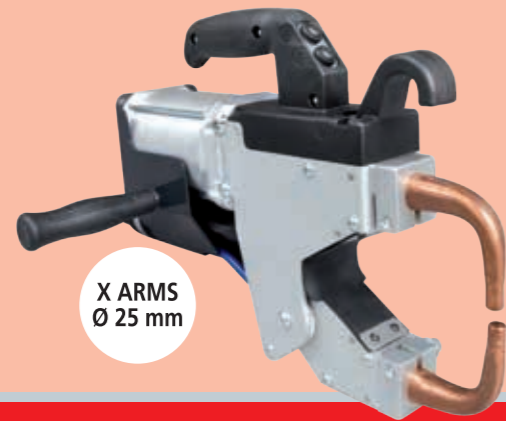

X ARMS
Ø 25 mm

X Arms - Caps Ø13 mm

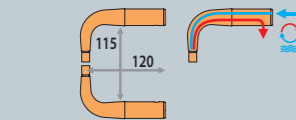

X1 8 bar/550 daN
050501

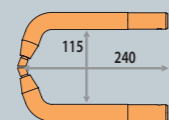

X2 8 bar/400 daN
050518

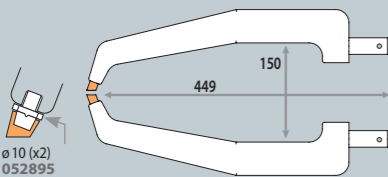

X4 8 bar/120 daN
050532

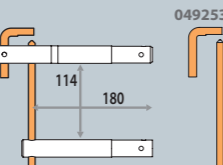

X5 8 bar/200 daN
050549

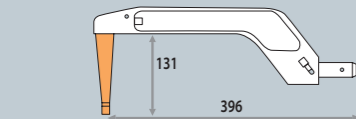

X4A 8 bar/150 daN
020702

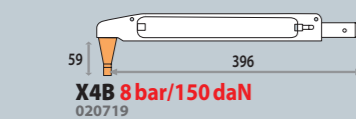

X4B 8 bar/150 daN
020719

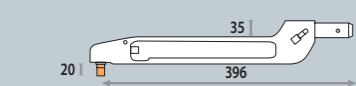

X4C 8 bar/150 daN
020726

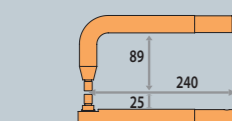

X6 8 bar/400 daN
050587

X4 (A, B & C) combinations

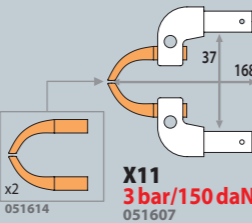
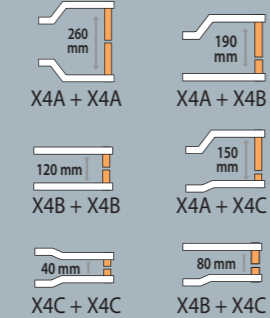

X11 3 bar/150 daN
051607

X ARMS PANELS

X4A (x2) + X5 + X2
022324

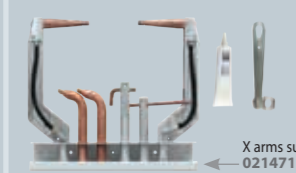

X4A (x2) + X4B + X4C + X2
020733

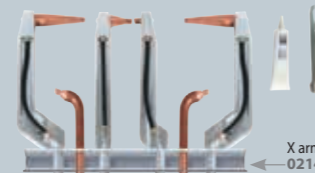

X arms support
021471

X arms support
021471

Remote control (BP)

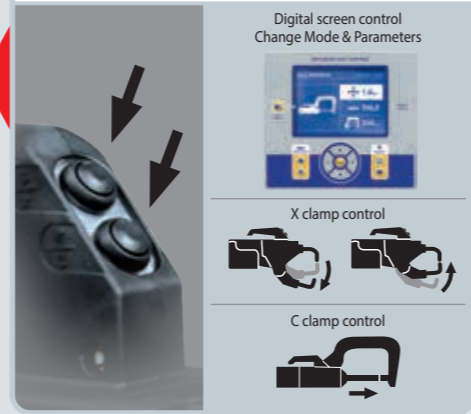

C ARMS PANELS



C2 + C3 + C4
060821
ALL IN 1 BOX



C10 + C3 + C5 + C6 + C9
076495

FOR GYSPOT PTI

550 daN

Transformer inside

9,9 kg including C1

- DOUBLE PRESSURE
- AIR COOLED + LIQUID COOLED / DOUBLE REFRIGÉRATION AIR + LIQUIDE
- Ø 10 mm



C Arms - Caps Ø13 mm

Bras isolés - Isolated arms - Isolierte Bügel

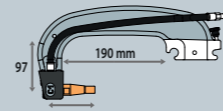

C1 8 bar/550 daN
021402

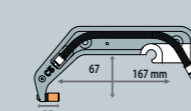

C5 8 bar/550 daN
022393

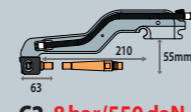

C2 8 bar/550 daN
022386

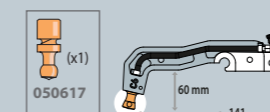

C6 8 bar/300 daN
022409



C3 8 bar/550 daN
021419

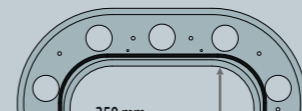

C7 8 bar/550 daN
021433

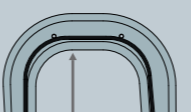

C4 8 bar/550 daN
021426

PTI arm support kit
077577

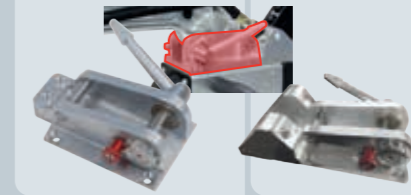

BP arm support kit
080089



Arm lock pin
062405



X Arms - Caps Ø13 mm

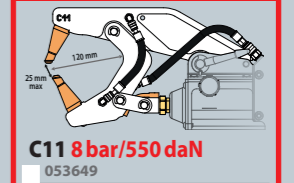

X11 8 bar/550 daN
053649

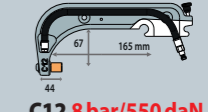

C12 8 bar/550 daN
022997

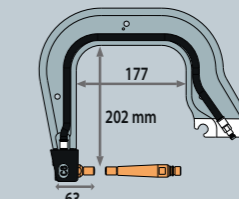

C8 8 bar/550 daN
021440

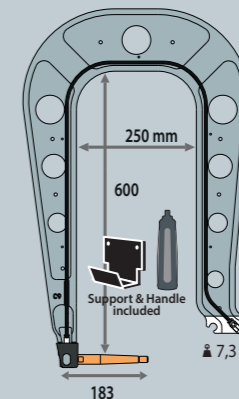

C9 8 bar/550 daN
020078

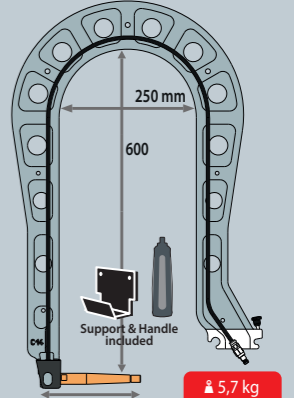

C14 8 bar/400 daN
023543

5,7 kg
22% saved

Option for C7

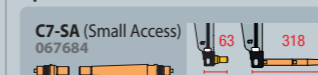

C7-SA (Small Access)
067684

Option for C9 & C14

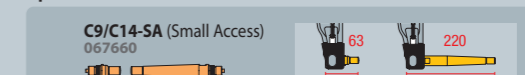

C9/C14-SA (Small Access)
067660



GYSPRESS



RIVETING

GYSPRESS 10T

6.5 bar 100 kN

10t

063303

070653

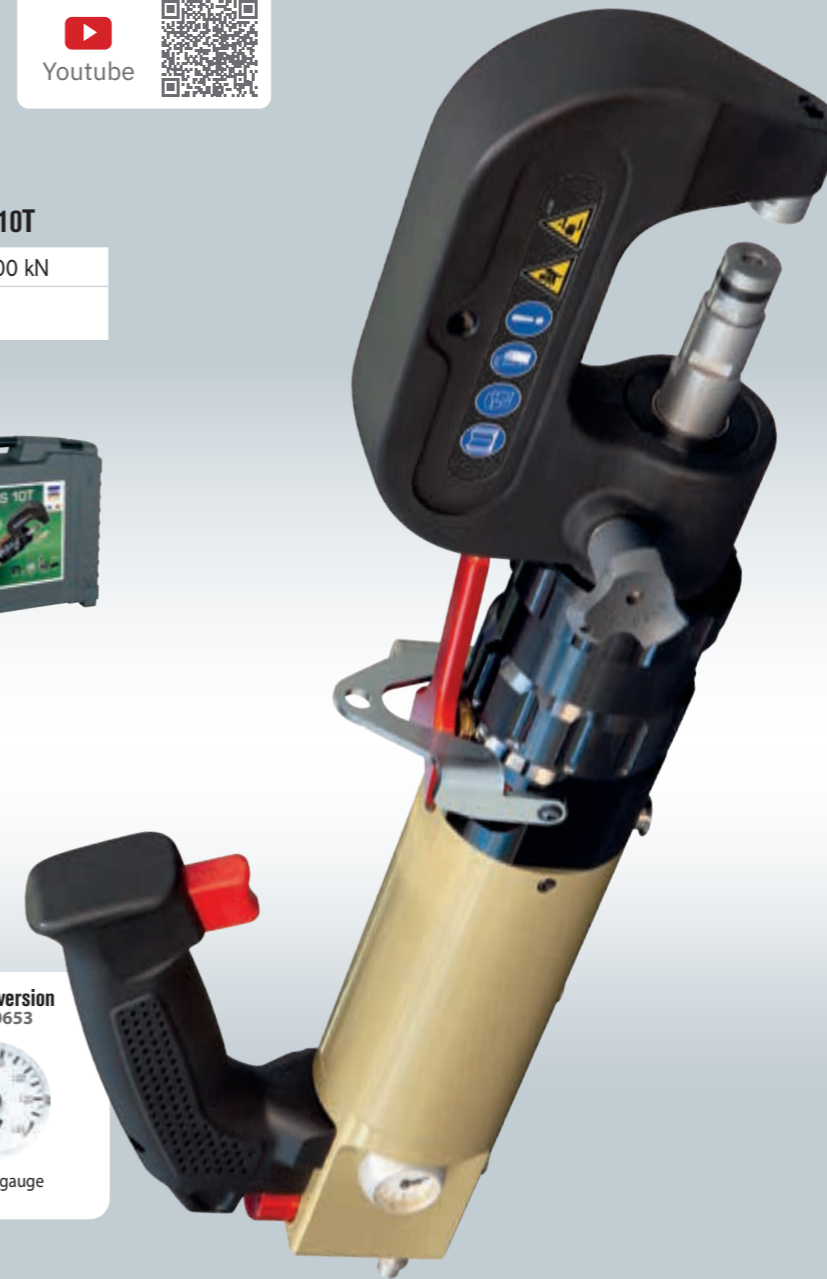

US version
070653



Pressure gauge
Psi



Discharge lever
- Levier de décharge - Auslösehebel



Speed control - Contrôle de la vitesse - Regelung
Werkzeuggeschwindigkeit



Pressure control
- Contrôle de la pression - Druckregelung



GYSPRESS 10T COMPLETE PACKS

	HR110 063310	XT11.21 - Extension for HR110 & HR210 058644	Standard 10T tool box 053694	6 x 50 rivets RAP - Nieten SPR 048706	HR210 + HR310 064089	24kN adapter 063822	Trolley+support 055391
GYSPRESS 10T 063303 070653	✓						
GYSPRESS 10T pack 1 066441			✓				
GYSPRESS 10T pack 2 082991				✓			
GYSPRESS 10T pack 3 064744			✓				✓

GYSPRESS 10T	73
GYSPRESS PREMIUM 10T PP	75
WORKSTATION	76
ADAPTERS	78
DIES BOXES & RIVETS	80
ACCESSORIES	83

 MADE IN FRANCE	AIR BAR	PRESSURE CONTROL	SPEED CONTROL				LxWxH cm / kg
				cm	kg		
GYSPRESS 10T	6.5 bar = 10 t (maxi 10 bar)	0 > 6.5 bar		39.5 x 180	6.2 (HR110 included)		58 x 50 x 15 / 12.1

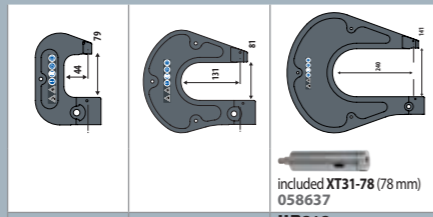

KIT WITH HR210 + HR310
064089

included XT31-78 (78 mm)
058637

	HR110	HR210	HR310
	063310	063327	063334
GYSPRESS 8T	✓	✓	—
GYSPRESS 10T	✓	✓	✓
GYSPRESS 8T PUSH PULL	✓	✓	✓
GYSPRESS PREMIUM 10T PUSH PULL	✓	✓	✓
GYSPRESS 10T PUSH PULL	✓	✓	✓
GYSPRESS 10T CONNECT	✓	✓	✓

XT31-40
Rallonges bras HR310
pour point milieu
- HR310 arm extension
for middle point

Compatible
8T PP/10T/10T PP
x2

066335

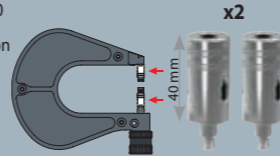

OPTIONS

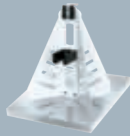

Riveting machine support for changing accessories (arms & dies)
- Support Riveteuse pour changements d'accessoires (bras & matrice)
- Supportständer

↓ 28 x 40 x 21,5 cm
⊗ 45 x 39 x 20 cm / 7,2 kg

054158



Trolley - Chariot

↓ 74 x 51 x 81 cm
⊗ 80 x 123 x 15 cm / 44 kg

054233

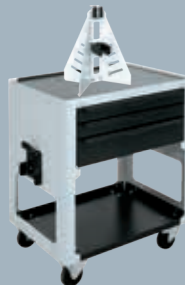

Trolley + Support
Chariot + Support

↓ 51 x 74 x 122 cm
⊗ 51,2 kg

055391

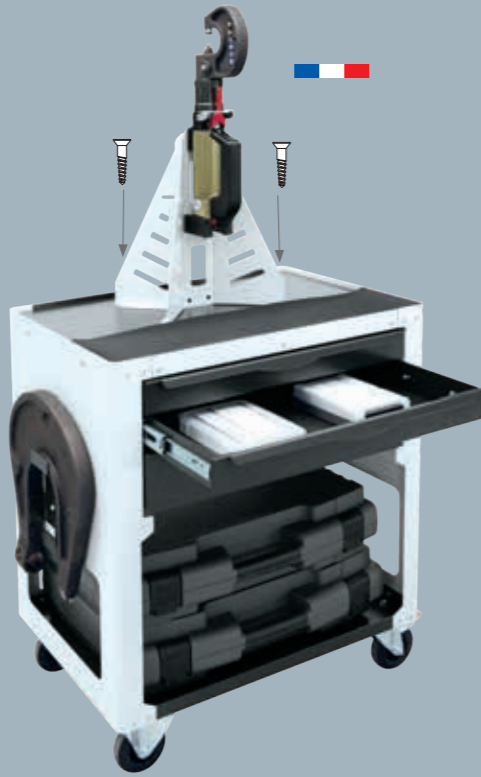

Pressure sensor
- Capteur d'effort
062115



Hydraulic body wrenches
(x2)
067325



Temporary - Serre-tôles - fasteners manual mounting

- (x10) Ø 2,4 mm 069664
- (x10) Ø 4,0 mm 069671
- (x10) Ø 4,8 mm 069688
- (x10) Ø 6,4 mm 069695

GYSPRESS 10T PREMIUM PUSH PULL COMPLETE PACKS

	HR110	XT11.21	Standard 10T tool box	6 x 50 rivets RAP	HR210 + HR310	24kN adapter	Trolley+support
GYSPRESS 10T PREMIUM PUSH PULL 077065	✓						
GYSPRESS 10T PPP pack 1 082519		✓					
GYSPRESS 10T PPP pack 2 082526			✓				
GYSPRESS 10T PPP pack 3 082533							✓



GYSPRESS

PREMIUM
PUSH PULL

GYSPRESS PREMIUM
10T PUSH PULL

6.5 bar 100 kN

10t

077065

070660



UNIQUE
PUSH PULL SYSTEM by GYS

AUTO
or MANUAL



LARGE OPENING

MORE
ACCESS

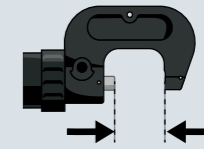

48.5 mm
(no dies)
23.5 mm
with B1/B2 dies

ERGONOMIC WITH QUICK SELECTION

WORK
FASTER



Push/Pull selection
- Sélection Push/Pull

MANUAL PULL MODE

OPENING
CONTROL



Manual/Automatic
selection
- Sélection Manuel/
Automatique



Pressure control
- Contrôle de la
pression
- Druckregelung



Speed control
- Contrôle de la vitesse
- Regelung Werk-
zeuggeschwindigkeit

US version
070660



Pressure gauge
Psi



UNIQUE
100%
No air inclusion
maintenance free, no oil refill

MADE IN FRANCE	AIR BAR	PRESSURE CONTROL	SPEED CONTROL	↕	⚖	📦
				cm	kg	kg
GYSPRESS 10T PREMIUM PUSH PULL	6.5 bar = 10 t (maxi 10 bar)	0 > 6.5 bar	↔	39.5 x 180	6.7 (HR110 included)	59 x 50 x 16 / 13.1



GYPRESS

SYNERGIC RIVETING WORKSTATION

PNEUMATIC HYDRAULIC



ACCESSIBILITY

16 languages

- FR PR CN
- GB CZ JP
- DE NL VN
- IT SE FI
- ES RU TR

★★★★ SYNERGIC RIVETS SETTINGS

Main panel



3 MODES

- MANUAL
- SYNERGIC
- CAR MANUFACTURERS

CAR MANUFACTURERS COMPATIBILITY

- ✓ VW GROUP
- ✓ MERCEDES-BENZ
- ✓ BMW
- ✓ TESLA
- ✓ FERRARI
- ✓ FORD
- ✓ RENAULT ALPINE
- ✓ GM

CONNECTIVITY

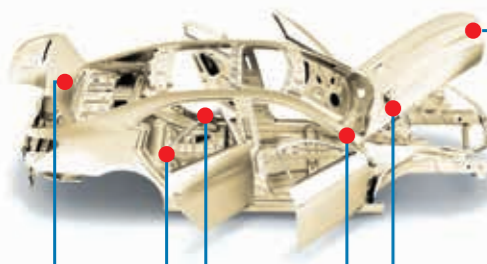

TRACEABILITY

History data export

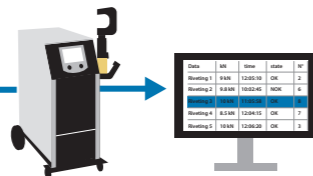

SOFTWARE UPDATE

Gyspress evolutions

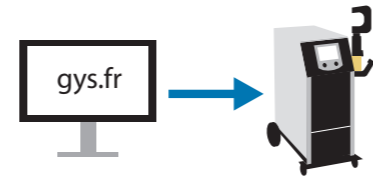

UNIQUE PUSH PULL SYSTEM by GYS

PUSH PULL SYSTEM by GYS

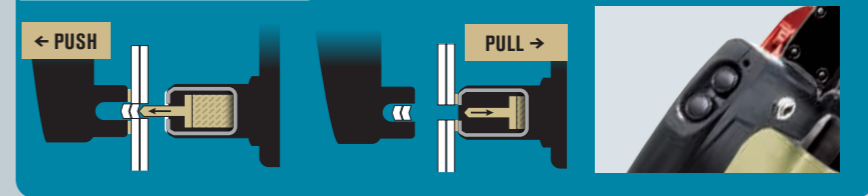

Gyspress support



Arms support



REGULATED PRESSURE CONTROL

POWER 10t

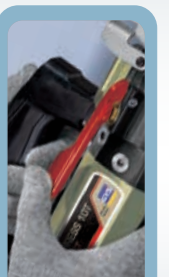

Discharge lever - Levier de décharge - Auslösehebel

WORKSTATION GYPRESS 10T PP CONTROL

6.5 bar 100 kN

10t

063860

included



OPTIONS

Pressure gauge - Capteur d'effort 10T PP CONTROL 071759



Youtube

Hydraulic body wrenches for GYPRESS 10T, 10T PushPull, 10T PP CONTROL (x2) 067325



MADE IN FRANCE WORKSTATION GYPRESS 10T PP CONTROL	230V	AIR BAR 6.5 bar = 10t (maxi 10 bar)	PRESSURE CONTROL 0 > 6.5 bar	SPEED CONTROL + -	LxWxH cm / kg	LxWxH cm / kg
					74 x 50 x 116 / 54	76 x 42 x 94 / 64.4



**BLIND RIVET ADAPTERS
- ADAPTATEURS POUR RIVETS AVEUGLES**

GYPESPRESS

Adaptators

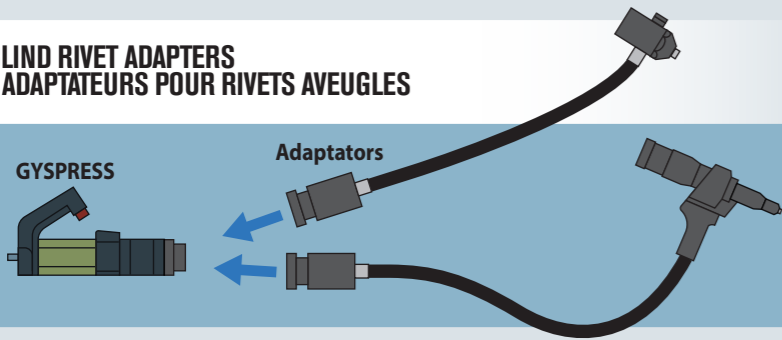

Compatibility

- GYPESPRESS 10T
- GYPESPRESS 10T PUSH PULL
- GYPESPRESS 10T PUSH PULL PREMIUM
- GYPESPRESS 10T CONNECT



Youtube

BLIND RIVET ADAPTER 24 kN - Adaptateur 24 kn pour rivets aveugles - Blindnietadapter 24 kN

24 kN STANDARD 600 mm
063822

Pour rivets POP - For BLIND rivets - Für Blindniet
Acier / Steel : Ø 4.0 → 6.4
Alu: Ø 4.0 → 7.8



INCLUDED

- 058446
- for standard rivets: Ø 3.2 x1 059221, Ø 3.6 x1 059238
- Ø 4.0 x1 059245, Ø 4.5 x1 059252

24 kN COMPACT 600 mm
077164

Pour rivets POP - For BLIND rivets - Für Blindniet
Acier / Steel : Ø 6.4
Alu: Ø 6.4 → 7.8

COMPACT HEAD



INCLUDED

- 058446
- for standard rivets: Ø 4.5 x1 081222, Ø 5.2 x1 079939

OPTION

- for extraction of self piercing rivet: Rivet-extraction insert - Buse d'extraction 24kN compact Ø 5 079946

HIGH ACCESSIBILITY



SPECIFIC STORAGE



PERFECT COMBO WITH ARCPULL

SPECIAL TEARING RIVETS
- Spécial arrachage de rivets
- Spezial-Zugnieten



OPTION FOR GYSPOT ARCPULL (details p.17)

for GYSPOT ARCPULL 350

ARC PULL RIVET BOX1 350 - 24kN 064584					
Stainless steel nail - Tige inox Ø 4 x 50 mm 064607	Barrel for stainless steel nail welding - Canon pour pose de tige inox 059634	Mandrel support - Support porte-goujon 059634	Nozzle + pad - Buse + patin 059641	Mandrel Ø4mm 049000	Buse d'extraction 24kN Ø 4 064683
x100	x1	x1	x1	x1	x1

BLIND RIVET ADAPTER 50 kN - Adaptateur 50 kn pour rivets aveugles - Blindnietadapter 50 kN



50 kN 1 m
064867
4.0 kg

Stroke adjustment - Réglage de la course de traction
0 → 25 mm

For BLIND rivets - Pour rivets POP - Für Blindniet

Steel / Acier : Ø 4.0 → 6.4
Alu: Ø 4.0 → 7.8

INCLUDED

Kit Standard



Complete kit 065987

- Ø 3.2 065994, Ø 3.5 066007, Ø 4.0 066014, Ø 4.5 066021, Ø 5.0 066038

OPTIONS

Steel / Acier : Ø 4.0 → 6.4
Alu: Ø 4.0 → 7.8

160 mm extension - Extension 160 mm - Verlängerung 160 mm
066144



Ø 8.0 → 9.8

Ø8.0/9.8mm nozzle-piece kit - Kit Rivets Ø8.0/9.8mm - Mundstückkit 8,0/9,8 mm
066045



M5 → M14
M5 → M8

Blind rivet nut pulling, Blind rivet bolt adapter kit - Kit 6 tirants pour pose d'écrous à sertir et goujons à sertir - Blindnietmuttern, Blindnietgewindebolzen-Kit
066076



OPTION FOR GYSPOT ARCPULL (details p.17)

for GYSPOT ARCPULL 350

ARCPULL RIVET BOX2 350 - 50kN 073388				
Ø 5 x 50 mm 070745	Long barrel + mandrel M5 - Canon long + mandrin M5 070738	Mandrel support - Support porte-goujon 059634	Buse + pad 059641	Buse d'extraction 50kN Ø 5 066151
x100	x1	x1	x1	x1

for GYSPOT ARCPULL 700

ARCPULL RIVET BOX 700 068452									
Ø 5 x 50 mm 070745	Long barrel + mandrel M5 - Canon long + mandrin M5 070738	Buse d'extraction 50kN Ø 5 066151	Mandrel support - Support porte-goujon 071377	Buse + pad 059641	Ring holder 059610	Rod for pulling rings - Fourche pour anneau 071384	Vis de butée 071384	Rod for pulling rings	Vis de butée
x100	x1	x1	x1	x1	x2	x1	x1	x1	x1

CONSUMABLES BOX FOR 50KN ADAPTER - Boîte consommables pour adaptateur 50kN - Zubehörbox für 50 kN Adapter

066168		M5, M6, M8, M10, M12, M14		M5, M6, M8		Ø 6.4, Ø 9.8
	Blind rivet nuts - Écrous à sertir	22.5 → 27, 24 → 28.5, 23.5 → 28	Blind rivet bolts - Goujons à sertir	0.5 → 3.0, 0.5 → 3.0, 0.5 → 3.0	Blind rivets - Rivets aveugles	2.8 → 4.8, 3.0 → 14.0
	Ø 50 066175, Ø 50 066182, Ø 50 066199, Ø 50 066205, Ø 50 066212, Ø 10 066229	x10, x10, x10, x10, x10, x5	Ø 50 066236, Ø 50 066243, Ø 50 066250	x10, x10, x10	Ø 50 066267, Ø 50 066274	x10, x10
	+ demo metal sheet - plaque de démonstration					

<p>Application of self-piercing rivets - Pose de rivets auto-perçants - Stanzniet-Verpressen</p> <p>2.0 < 6.5 mm 3 < 5.8 bar</p>	<p>Application of solid rivets - Pose de rivets pleins - Vollniet-Verpressen</p> <p>2.3 < 8.3 mm 5.3 < 8 bar</p>	<p>Application of Flow-form rivets - Pose de rivets Flow-Form - Setzen v. Fließformnieten</p> <p>2.3 < 8.3 mm</p>	<p>Extraction de rivets - Extraction of rivets - Niet-Auspressen</p> <p>2.3 < 8.3 mm 8 bar</p>	<p>Metal sheet punching and shaping - Perçage et formage des tôles pour rivets pleins - Vollniet-Lochstanzen/Prägen</p> <p>2.3 < 8.3 mm 8 bar</p>
---	---	--	--	---

DIES BOXES - Boîtes matrices - Matrzensätze

STANDARD

STANDARD 8T/10T
for 8T 10T
053694
Included XT11-21 058644

x1	x1	x1	x1	x1	x1	x1	x2	x1	x1	x1	x1	x1	x2	x4
A1	A2	B1	B2	F1	F2	D17	E1	E2	T1	T2				
Self-piercing rivets				Flow-form rivets		Extraction		Punching				key - clé		seals - joints
Ø 3.2 > 3.5	Ø 3.3	Ø 5 > 5.3	Ø 5.3	Ø 6 - A1/2/3 S0/1/2/3/4/5/6		Ø 3.3 > 4.8 Ø 3.9 > 5.3		Ø 6						x1

STANDARD 8T/10T PUSH PULL
for 8T PP 10T PP 10T CONTROL
058361
Included XT31-60 - 60 mm extension for HR310 (use with ST1, T5, T7) 057135
+ XT11-21 058644

x1	x1	x1	x1	x1	x1	x2	x1	x1	x1	x1	x1	x2	x4	
A1	A2	B1	B2	F1	F2	D17	E1	E2	ST1	T5	T7			
Self-piercing rivets				Flow-form rivets		Extraction		Punching				key - clé		seals - joints
Ø 3.2 > 3.5	Ø 3.3	Ø 5 > 5.3	Ø 5.3	Ø 6 - A1/2/3 S0/1/2/3/4/5/6		Ø 3.3 > 4.8 Ø 3.9 > 5.3		Ø 6						x1

Ideal for aluminum & mild steel - Idéal aluminium et aciers doux

Low pressure Ø 6.4 mm

High pressure Ø 6.4 mm

BREVET GYS / GYS PATENT n° US 11,712,732

Ne pas utiliser avec une Gyspress 8T & 8T PP - Do not use with Gyspress 8T & 8T PP

Flow-Form Ø 6 mm	Flow-Form Ø 8 mm	Punching Ø 10 mm holes
KIT RMB PP05 for 10T PP 10T CONTROL 066366	KIT RMB 08 PREMIUM for 10T 10T PP 10T CONTROL 066403	KIT RMB 14 PREMIUM for 10T 10T PP 10T CONTROL 071186
x1 x1 x1 ST3 T12 T13 Punching Ø 6.7	x1 x1 x1 T14 T15 T16 Punching Ø 6.7	x1 x1 x1 T17 T18 T19 Punching Ø 6

GM

RMB 11 for 10T
071087

RMB PP04 for 10T PP 10T CONTROL
071063

Included XT31-60 - 60 mm extension for HR310

x1	x1	x1	x1	x1	x1	x1	x1	x1	x1	x3	x1	x1	x2	x2	x4	
F1	F2	F6	E9	E11	T1	T2					T17	T18	T19	D18	D17	
Flow-form rivets			Extraction								Punching				key - clé	seals - joints
Ø 6			Ø 6 > 8								Ø 6					

FERRARI

RMB 06
for 8T 10T 8T PP 10T PP 10T CONTROL
059009

x1	x1	x1	x1	x1	x1	x2	x1	x1	x1	x2	x4	
B4	B5	B6	S3	S7	S8	D17	E1	E2	E13			
Self-piercing rivets				Extraction						key - clé		seals - joints
Ø 3.9 Ø 4.75 Ø 3.9 Ø 4.75				Ø 3.3 > 4.8 Ø 3.9 > 5.3 Ø 4.75								

VW GROUP

RMB 03 for 8T 10T 8T PP 10T PP 10T CONTROL
054257

x1	x1	x1	x1	x1	x1	x1	x1	x1	x1	x1	x1	x1	x1	x1	x1	x1	x2	x4									
A1	B1	S3	S7	S8	D8	D9	D17	D1	D2	D3	D4	D13	E2	S1	S4	S5	D5	D6	D7	D10	D11	D12	D15	D16			
Self-piercing rivets				Solid rivets		Extraction		Punching																		key - clé	seals - joints
Ø 3.2 > 3.5 Ø 5 > 5.3 Ø 3.9 Ø 4.75				Ø 4 Ø 6		Ø 3.2 Ø 5.3 Ø 3.2 Ø 5.3 Ø 3.2 Ø 5.3 Ø 8 Ø 4.8 Ø 4 > 8 Ø 4 Ø 6																					

NIO

RMB PP08 for 10T 10T PP 10T CONTROL
072404

Included XT31-60 - 60 mm extension for HR310

x1	x1	x1	x1	x1	x1	x1	x1	x1	x1	x1	x1	x3	x1	x2	x1	x2	x4	
B1	B2	F1	F2	F6	E2	E3	E9	E11	T5	ST1	T7	T17	T18	T19	D17	D18		
Self-piercing rivets		Flow-form rivets		Extraction												key - clé		seals - joints
Ø 5.3 Ø 5.3		Ø 6 Ø 6		Ø 5.3 Ø 6														

MERCEDES-BENZ

RMB 07 for 10T
064454

Included XT31-60 - 60 mm extension for HR3 (use with E3, E4, E5, E9, E10, E11) 057135

x1	x1	x1	x1	x1	x1	x1	x1	x1	x1	x1	x1	x1	x1	x1	x1	x1	x1	x2
F1	F2	F3	F4	F5				E9	E10	E11	T1	T2	T3	T4				
Flow-form rivets					Extraction					Punching					clé - key			
Ø 6 - A1/2/3 S0/1/2/3/4/5/6					S28/38/48/58/68 S08/18 Ø 5.3 > 8 Ø 6 Ø 8 Ø 6 > 8 Ø 8 Ø 6					Ø 6					Ø 8			

RMB PP01 for 8T PP 10T PP 10T CONTROL
058378

Included XT31-60 - 60 mm extension for HR3

x1	x1	x1	x1	x1	x1	x1	x1	x1	x1	x1	x1	x1	x1	x1	x1	x1	x1	x2
F1	F2	F3	F4	F5				E9	E10	E11	ST1	ST2	T5	T7	T8	T10		
Flow-form rivets					Extraction					Punching					clé - key			
Ø 6 - A1/2/3 S0/1/2/3/4/5/6					S28/38/48/58/68 S08/18 Ø 6 > 8 Ø 8 Ø 6					Ø 6 Ø 8 Ø 6 Ø 6 Ø 6 Ø 8 Ø 8					Ø 8			

FORD

RMB PP02 for 10T 8T PP 10T PP 10T CONTROL
058835

Included XT31-60 - 60 mm extension for HR3 (use with E7 & E12) 057135

x1	x1	x1	x1	x1	x1	x1	x1	x1	x1	x1	x2	x4
B1	G1	G2	G3	G4	G5	G6	E7	E12				
Self-piercing rivets								Extraction		key - clé		seals - joints
Ø 5 > 5.3								Ø 5 > 5.3				

JAGUAR / LAND ROVER

RMB 02
for 8T 10T 8T PP 10T PP 10T CONTROL
054271

x1	x1	x1	x1	x2	x1	x1	x2	x4
B1	B2	B3	S8	D17	E1	E6		
Self-piercing rivets				Extraction		clé - key		seals - joints
Ø 5 > 5.3 Ø 5.3 Ø 4.8 Ø 4.75				Ø 3.3 > 4.8 Ø 3.3 > 4.8				

BMW

RMB 01
for 8T 10T 8T PP 10T PP 10T CONTROL
054240

x1	x1	x1	x1	x1	x1	x2	x4	
A1	A2	B1	B2	E1	E2			
Self-piercing rivets				Extraction		key - clé		seals - joints
Ø 3.2 > 3.5 Ø 3.3 Ø 5 > 5.3 Ø 5.3				Ø 3.3 > 4.8 Ø 3.9 > 5.3				

RMB 12 for 10T
071094

RMB PP07 for 10T PP 10T CONTROL
071070

Included XT31-60 - 60 mm extension for HR310

x1	x1	x1	x1	x1	x1	x1	x1	x1	x1	x1	x1	x1	x1	x1	x3	x1	x1	x2	x2	x4	
B1	B3	I1	I2	I3	F1	F2	F6	E3	E13	T1	T2			ST1	T5	T7	T17	T18	T19	D18	D17
Self-piercing rivets					Flow-form rivets			Extraction		Punching					key - clé		seals - joints				
Ø 5 > 5.3					Ø 6			Ø 3.3 > 4.8 Ø 9		Ø 6											

PORSCHE

RMB 10 for 10T
069299

RMB PP06 for 10T PP 10T CONTROL
069305

Included XT31-60 - 60 mm extension for HR310

x1	x1	x1	x1	x1	x1	x1	x1	x1	x1	x1	x1	x1	x1	x1	x3	x1	x2	x2	x4
B3	F2	E9	E11			T1	T2			T5	ST1	T7			T17	T18	T19	D17	
Flow-form rivets		Extraction		Punching					key - clé		seals - joints								
Ø 6		Ø 6 > 8		Ø 6															

TESLA

RMB 09 for 8T 10T 8T PP 10T PP 10T CONTROL
059931

x1	x1	x1	x1	x1	x1	x1	x1	x1	x1	x1	x1	x1	x1	x1	x1	x1	x2	x4	
B1	H1	H2	H3	H4	H5	H6	H7	H8											
Self-piercing rivets																	key - clé		seals - joints
Ø 5 > 5.3 Ø 5.3																			

RMB 13 for 10T
071100

RMB PP03 for 8T PP 10T PP 10T CONTROL
059092

Included XT31-60 - 60 mm extension for HR3 (use with E2, E3, E9, E10) 057135

x1	x1	x1	x1	x1	x1	x2	x1	x1	x1	x1	x1	x1	x1	x1	x1	x1	x1	x1	x2	x4
B1	S7	S8	F3	F4	F5	D17	E2	E3	E9	E10					ST2	T8	T10			
Self-piercing rivets				Flow-form rivets			Extraction		Punching					key - clé		seals - joints				
Ø 5 > 5.3 Ø 4.75				S28/38/48/58/68 S08/18			Ø 3.9 > 5.3 Ø 5.3 > 8		Ø 6 > 8 Ø 8					Ø 8 Ø 8						

DIES - Matrices - Matrizen

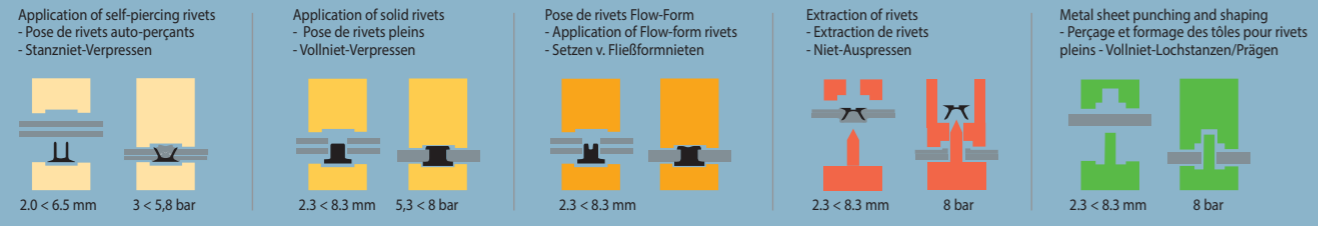

Ø 8																				
A1	A2	B1	B2	B3	B4	B5	B6	D1	D2	D3	D4	D5	D6	D7	D8	D9	D10	D11	D12	D13
055698	055704	055711	055728	055735	059016	059023	059030	055971	055988	055995	055742	056008	056015	056022	056039	056046	055674	056060	056053	055759
A1+A2		B1+B2																		
054295		054301																		

D15	D16	D17	D18	E1		E2	E3	E6	E7	E9	E10	E11	E12	E13	F1	F2	F3	F4	F45						
056077	056084	055681	071155	055865	054288	055766	057005	057142	057159	058606	058613	058620	058828	059085	055773	055780	055797	055803	083547						
				E1+E2																		F1+F2		NEW	
				054318																		054714			

F5	F6	G1	G2	G3	G4	G5	G6	H1	H2	H3	H4	H5	H6	H7	H8	I1	I2	I3	J1	J2
055810	071148	057173	057180	057197	057203	057210	057227	068230	068247	068254	068261	068278	068285	068292	068308	071117	071124	071131	071674	071902

Ø 6													Ø 6		Ø 6		Ø 8		Ø 6.7	
S1	S3	S4	S5	S7	S8	ST1	ST2	ST3	T1	T2	T3	T4	T5	T7	T8	T10	T12	T13		
057036	057043	057050	057067	057074	057081	058071	058088	066397	057098	059078	057104	055827	055834	058019	058033	058040	058064	066373	066380	
													T1+T2							
													054707							

BREVET GYS / GYS PATENT n° US 11,712,732

Ø 6.7		Ø 6		Ø 8		Ø 10									
T14	T15	T16	T17	T18	T19	T20	T25								
066410	066427	068964	066434	069312	069329	071254	069336	070936	070943	071261	070950	082830	082847	082861	082854

SELF PIERCING RIVETS (SPR)
- Rivets auto-perçants (RAP) - Stanznieten

Steel - Acier - Stahl

Complete box 048706

Ø 3,3 x 3,5 mm x 50	Ø 3,3 x 4 mm x 50	Ø 5,3 x 4 mm x 50	Ø 5,3 x 5 mm x 50	Ø 5,3 x 6 mm x 50	Ø 5,3 x 8 mm x 50	Ø 5,3 x 7 mm	Ø 5,3 x 9 mm
x200 048232	x200 048249	x100 048256	x100 048263	x100 048270	x100 048225	x100 048638	x100 048645

SPECIAL CENTER PUNCH
- Pointeau centreur - Spezialkörner

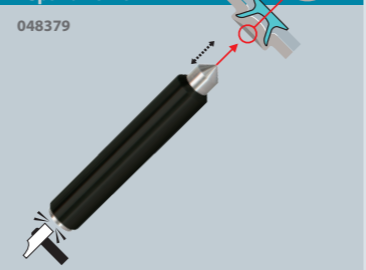

HYDROPNEUMATIC TOOL FOR BLIND RIVETS
- Riveteuse hydro-pneumatique - Hydro-pneum. Blindnietgerät

For BLIND rivets - Pour rivets POP - Für Blindniet
 Steel → 6.4 mm
 Alu → 7.8 mm
 Ø 4.0 → 7.8

HR21
max 21 000 N (6 bar)
055407

MADE IN ITALY

included (x3) 058446

For standard rivets Ø 4.0 51508

For Magnarive rivets Ø 4.5 51507

Option HR21 extension 100 mm 063105

CORDLESS RIVETER - Riveteuse sur batterie
- Akku-Blindnietgerät

For BLIND rivets - Pour rivets POP - Für Blindniet
 Ø 4.0/4.8/5.0/6.0/6.4

TWO ER20
max 20 000 N (6 bar)
10-20 V universal fast charger (30 min)
2.0 kg
064461

BRUSHLESS motor

2 x 20V/2Ah Li-ion battery

HYDROPNEUMATIC TOOL FOR BLIND RIVETS
hydro-pneumatique - Hydro-pneum. Blindnietgerät

For BLIND rivets - Pour rivets POP - Für Blindniet
 Steel / Acier Ø 4.0/4.8/6.4
 Alu Ø 4.0/4.8/6.4

HR14
max 14 000 N
057241

Made in Taiwan

MANUAL TOOL FOR BLIND RIVETS
- Riveteuse manuelle - Manueller Blindnietgerät

For BLIND rivets - Pour rivets POP - Für Blindniet
 Steel / Acier Ø 3.2/4.0/4.8/6./6.4
 Alu Ø 3.2/4.0/4.8/6./6.4

061323
Made in Taiwan

HYDROPNEUMATIC TOOL FOR RIVET NUTS
hydro-pneumatique riv 998 - Hydro-pneum. Blindnietmuttergerät

Sealing nuts - Ecrous à sertir - Blindnietmuttern

RIV 998

For sealing nuts from M3 to M12
 Pour la pose d'écrous à sertir M3 à M12

max 19 000 N (6 bar)
 included accessories for sealing nuts:
 - livré avec accessoires pour écrous à sertir:

- ✓ M3 ✓ M4
- ✓ M5 ✓ M6
- ✓ M8 ✓ M10
- ✓ M12

055414

MADE IN ITALY

HYDROPNEUMATIC TOOL FOR BLIND RIVETS
- Riveteuse hydro-pneumatique - Hydro-pneum. Blindnietgerät

For BLIND rivets - Pour rivets POP - Für Blindniet
 Steel / Acier Ø 3.2/4.0/4.8
 Alu Ø 3.2/4.0/4.8

HR9
max 9 000 N
057234

Made in Taiwan



MIG-MAG GMAW-FCAW

TRADITIONAL

GYS AUTO	86
----------	----

INVERTER

E GYS AUTO	88
P GYS AUTO	90
AUTOPULSE	92



ACCESSORIES & CONSUMABLES	96
---------------------------	----

MIG/MAG TRADITIONAL SYNERGIC

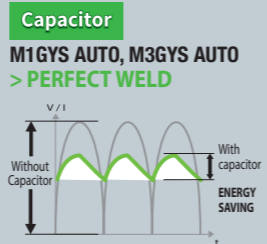

SYNERGIC EASY TO USE
Auto adaptative wire speed
- Réglage automatique de la vitesse
- Automatische Einstellung der Drahtgeschwindigkeit

M1 GYS AUTO

15 → 160 A Capacitor
230V • 1~
032903
208/240V • 1~
032088

6m
2m

with accessories

T1 GYS AUTO DV

15 → 200 A
400V • 3~ / 230V • 3~
032927

with accessories

M3 GYS AUTO

15 → 160 A Capacitor
230V • 1~
032880

6m

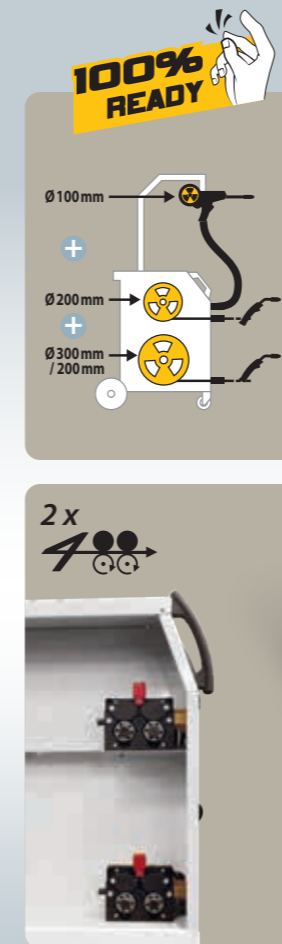

Protection gas
Argon+CO₂ (Steel, Inox)
Argon (ALU/CuSi3/CuAl8)
CO₂PUR (Steel)

Spool Gun Torch
- Torche motorisée Spool Gun
- Spool Gun Brenner



SPOOL GUN + Support
for M3 GYS AUTO



MADE IN FRANCE	MADE IN GYS CHINA	CE MARKING 60974/1	50/60 Hz	A	min → max	Reg	Ø mm			Electronic Control	EN60974-1 (40°C)			Original equipment Equipment d'origine Originalausstattung Equipamiento de fabrica	LxWxH cm / kg	Protected & compatible power generator (+/-15%)	
							100 (spoolgun)	200	300		IA (60%)	X% (I2 max)	Ø mm				
■	■	■	230V 1~	16	15 → 160	6	option	■	■	4	90	140A@15%	0.6+1	0.6/0.8	0.8	78 x 38 x 67 / 56	4,5 kVA
			208/240V 1~													37 x 79 x 67 / 57.5	
■	■	■	230V 3~/400V 3~	10	15 → 200	7	option	■	■	4	110	150A@25%	0.6+1	0.6/0.8	0.8	37 x 78 x 67 / 62	5.2 kVA
■	■	■	230V 1~	16	15 → 160	6	■	■	■	4	90	140A@15%	0.6+1	0.6/0.8 0.8/1.0	2 x 0.8	74 x 40 x 85 / 77.5	4,5 kVA



E GYS AUTO

MIG/MAG INVERTER SYNERGIC

Lastest generation
colour screen 3.5"

EASY



EXPERT

Pre-gas / Creep speed/ Hotstart /
Crater filler / Burnback / Post-gas



Screen protection -
Protection d'écran -
Bildschirmschutz
079885



EASY TO SETUP



MODES

- MANUAL
- SYNERGIC EASY / EXPERT
- 2T
- 4T
- SPOT
- DELAY

FONCTIONS

- TRACEABILITY
- PORTABILITY
- +500 JOBS can be saved

SYNERGIES

- STEEL
- AlSi
- AlMg
- Cu Si 3 / CuAl 8
- CrNi

UPDATES

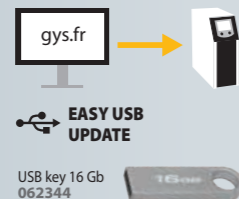

E1 GYS AUTO

10 **200 A** 230V 1~ PFC

with accessories :

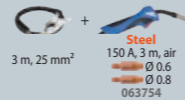

075122

E2 GYS AUTO

10 **200 A** 230V 1~ PFC

with accessories :

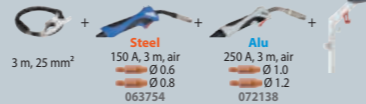

075139

E3 GYS AUTO

10 **200 A** 230V 1~ PFC

with accessories :



075160



4 m³ (20L)

1 x

6 m



PFC POWER FACTOR CORRECTION

195 V ← 265 V

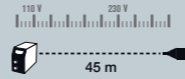

Cable support E2/E3 077300

2 x 4 m³ (20L)

2 x 4 m³ (20L)

2 x

6 m

6 m

3 x

E1 GYS AUTO 200 A • × 1

E2 GYS AUTO 200 A • × 2

E3 GYS AUTO 200 A • × 3

MADE IN FRANCE	CE NORM. 60974/1	50/60 Hz	A	6 m	min → max A	Ø mm		Electronic Control	EN60974-1 (40°C)		Original equipment Equipement d'origine Originalausstattung Equipamiento de fabrica	LxWxH cm / kg	Protected & compatible power generator (+/-15%)	
						200	300		IA (60%)	X% (I2 max)				
▪	E1 GYS AUTO	230V 1~	16	6 m	10 → 200	▪	▪		145	200 A @ 20%	0.6 → 1	Acier Type B 0.6/0.8	79 x 37 67 / 42.6	9KVA
▪	E2 GYS AUTO	230V 1~	16	6 m	10 → 200	▪	▪		145	200 A @ 20%	0.6 → 1	Acier Type B 0.6/0.8 Alu Type B 0.8/1	72 x 37 x 105 / 59.5	9KVA
▪	E3 GYS AUTO	230V 1~	16	6 m	10 → 200	▪	▪		145	200 A @ 20%	0.6 → 1	Acier Type B 0.6/0.8 Acier Type B 0.8/1 Alu Type B 0.8/1	73 x 38 x 108 / 64	9KVA





P GYS AUTO

MIG/MAG PULSE SYNERGIC

NEW

Lastest generation colour screen 3.5"

16 languages

- French
- English
- German
- Italian
- Spanish
- Portuguese
- Czech
- Polish
- Dutch
- Swedish
- Russian
- Chinese
- Japanese
- Vietnamese
- Finnish
- Turkish

EASY



EXPERT

Pre-gas / Creep speed/ Hotstart / Crater filler / Burnback / Post-gas



EASY TO SETUP



Screen protection - Protection d'écran - Bildschirmschutz 079885

MODES

EASY

- SYNERGIC STANDARD
- SYNERGIC PULSE

EXPERT

- MANUAL
- SYNERGIC STANDARD
- SYNERGIC PULSE

TORCH

2T

4T

SPOT

SPOT DELAY

FONCTIONS

TRACEABILITY

PORTABILITY

+500 JOBS can be saved

SYNERGIES

STEEL - ACIER

ALU

STAINLESS STEEL - INOX

BRAZING - BRASAGE

+40 SYNERGIES

UPDATES



EASY USB UPDATE

USB key 16 Gb 062344

10 → 220 A
Ideal 0.6 mm

P1 GYS AUTO

10 → 220 A 230V 1~ PFC

with accessories :

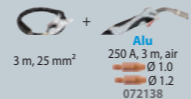

080584

P1 GYS AUTO 208-240V

10 → 220 A 208>240V 1~ PFC

with accessories :

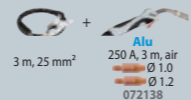

080911



1 x

P1 GYS AUTO 220 A • × 1

P2 GYS AUTO

10 → 220 A 230V 1~ PFC

with accessories :

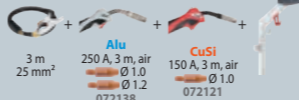

083134

P2 GYS AUTO 208-240V

10 → 220 A 208>240V 1~ PFC

with accessories :

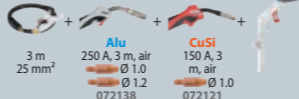

083189



2 x

P2 GYS AUTO 220 A • × 2

P3 GYS AUTO

10 → 220 A 230V 1~ PFC

with accessories :

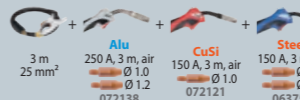

080591

P3 GYS AUTO 208-240V

10 → 220 A 208>240V 1~ PFC

with accessories :

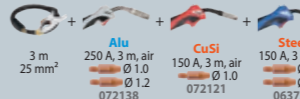

080928

Cable support P2/P3 077300



3 x

P3 GYS AUTO 220 A • × 3

MADE IN FRANCE	CE NORM. 60974/1	50/60 Hz	A	6m	min → max	A	200	300	Electronic Control	EN60974-1 (40°C)		Ø mm	Original equipment Equipement d'origine Originalausstattung Equipamiento de fabrica			LxWxH cm / kg	Protected & compatible power generator (+/-15%)
										IA (60%)	X% (I2 max)		Alu Type B 1.0/1.2	Steel Type B 0.8/1.0	Steel Type B 0.6/0.8		
▪	P1 GYS AUTO	230V 1~	16		10 → 220	▪	▪	1 x	150	220 A @ 20 %	0.6 → 1.2	Alu Type B 1.0/1.2			78 x 45 x 80 / 45	9KVA	
▪	P1 GYS AUTO 208-240V	208 > 240V 1~	16	6m	10 → 220	▪	▪	1 x	150	220 A @ 20 %	0.6 → 1.2	Alu Type B 1.0/1.2			78 x 45 x 80 / -	9KVA	
▪	P2 GYS AUTO	230V 1~	16		10 → 220	▪	▪	2 x	150	220 A @ 20 %	0.6 → 1.2	Alu Type B 1.0/1.2	Steel Type B 0.8/1.0		86 x 63 x 93 / 58	9KVA	
▪	P2 GYS AUTO 208-240V	208 > 240V 1~	16	6m	10 → 220	▪	▪	2 x	150	220 A @ 20 %	0.6 → 1.2	Alu Type B 1.0/1.2	Steel Type B 0.8/1.0		86 x 63 x 93 / -	9KVA	
▪	P3 GYS AUTO	230V 1~	16		10 → 220	▪	-	3 x	150	220 A @ 20 %	0.6 → 1.2	Alu Type B 1.0/1.2	Steel Type B 0.8/1.0	Steel Type B 0.6/0.8	86 x 63 x 93 / 62	9KVA	
▪	P3 GYS AUTO 208-240V	208 > 240V 1~	16	6m	10 → 220	▪	-	3 x	150	220 A @ 20 %	0.6 → 1.2	Alu Type B 1.0/1.2	Steel Type B 0.8/1.0	Steel Type B 0.6/0.8	86 x 63 x 93 / -	9KVA	



91

P GYS AUTO
PULSE SYNERGIC MIG
GMW FCAW



MIG/MAG DOUBLE PULSE SYNERGIC

Latest generation
colour screen 5"
800 x 480 (WVGA)



ACCESSIBILITY

- 3 interface levels
 - EASY
 - EXPERT
 - ADVANCED

- 16 languages
 - French
 - English
 - German
 - Italian
 - Spanish
 - Portuguese
 - Czech
 - Polish
 - Dutch
 - Swedish
 - Russian
 - Chinese
 - Japanese
 - Vietnamese
 - Finnish
 - Turkish

EASY



3 INTERFACE LEVELS

ADVANCED



EXPERT

Pre-gas / Hot Start / Upslope / Downslope / Crater filler / Post-gas



500+ JOBS can be saved



TRACEABILITY



PORTABILITY



MODES

- DYNAMIC STANDARD
- PULSE
- PULSE IN PULSE
- MANUAL
- COLD PULSE**

FULLY DIGITAL

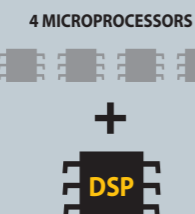

65+ SYNERGIES

Find all the synergies: Retrouvez toutes les synergies: Finde alle Synergien:



- STEEL
- Cu Si 3 / Cu Al 8
- ALU

UPDATES

EASY USB UPDATE

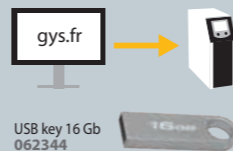

OPTIONS

PUSH PULL TORCH 24 V



MB 25
4 m
046283



x5 (M6-0.6)
x5 (M6-0.8)
x5 (M6-0.1.0)
x5 (Alu-M6-0.1.0)
x5 (Alu-M6-0.1.2)

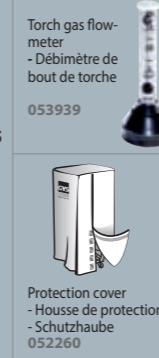

Protection cover
- Housses de protection
- Schutzhaube
052260

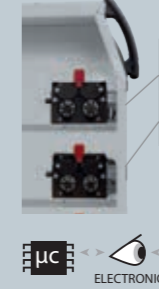

AUTOPULSE 220-M1	
1	Ø 200 / 300
-	-

AUTOPULSE 220-M2	
1	Ø 200 / 300
2	Ø 200 / 300

AUTOPULSE 220-M1

10 220 A 230V 1~ PFC

with accessories:

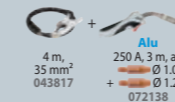

065024



AUTOPULSE 220-M2

10 220 A 230V 1~ PFC

with accessories:

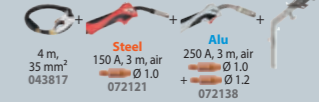

069855

AUTOPULSE 220-M2 208-240V

10 220 A 208>240V 1~ PFC

with accessories:



069862



PFC POWER FACTOR CORRECTION

185 V ← 265 V

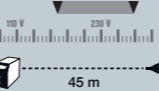

220 A • x1

220 A • x2

	50 / 60 Hz	A	Ø mm	A	min → max	SPPOOLGUN	PUSH/PULL	200 / 300	Cooling system	Original equipment Equipement d'origine Originalausstattung Equipamiento de fabrica	EN60974-1 (40°C)	IA (60%)	X% (12 max)	LxWxH cm / kg	Protected & compatible power generator (+/-15%)
AUTOPULSE 220-M1	230 V · 1~	8 m	16	0.6 → 1.2	10 → 220	-	OPTION	■ ■	Air	ALU : Type B 1.0 / 1.2	150	220 A @ 20%	75 x 41 x 94 / 65.5	10 kVA	
AUTOPULSE 220-M2	230 V · 1~	8 m	16	0.6 → 1.2	10 → 220	-	OPTION	■ ■	Air	ACIER : Type B 0.8 / 1.0 mm ALU : Type B 1.0 / 1.2	150	220 A @ 20%	74 x 41 x 93 / 78.8	10 kVA	
AUTOPULSE 220-M2 208-240V	208 > 240 V · 1~												74 x 40 x 93 / 79.8		



MIG/MAG DOUBLE PULSE SYNERGIC

BODYSHOP SPECIFIC
COLD PULSE
CuSi3 Ø 0.8/1



Helmet not included

2 x 4 m³ (20L)

3 x

8 m

PFC POWER FACTOR CORRECTION

185 V ← 265 V

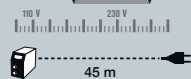

AUTOPULSE 220-M3

1				PP
2				
3				

LIC ELECTRONIC

AUTOPULSE 220-M3
10 **220 A** 230V 1~ PFC

with accessories:
4 m, 35 mm² 043817 + CuSi 150 A, 3 m, air Ø 1.0 072121 + Steel 150 A, 3 m, air Ø 0.8 063754 + Alu 250 A, 3 m, air Ø 1.0 Ø 1.2 072138

AUTOPULSE 220-M3 208-240V
10 **220 A** 208>240V 1~ PFC

with accessories:
4 m, 35 mm² 043817 + CuSi 150 A, 3 m, air Ø 1.0 072121 + Steel 150 A, 3 m, air Ø 0.8 063754 + Alu 250 A, 3 m, air Ø 1.0 Ø 1.2 072138

062481

OPTIONS

PUSH PULL TORCH 24 V

MB 25 4m 046283

Motor inside

Torch gas flow-meter - Débitmètre de bout de torche 053939

MB 15 / MB 25 (250 A) 077089

Protection cover - Housse de protection - Schutzhaube 052260

- x5 (Mg-0.6)
- x5 (Mg-0.8)
- x5 (Mg-1.0)
- x5 (Mg-0.8)
- x5 (Mg-1.0)
- x5 (Alu - Mg-0.10)
- x5 (Alu - Mg-0.12)

AUTOPULSE 320-T1

1				PP
2				
3				

LIC ELECTRONIC

AUTOPULSE 320-T3

1				PP
2				
3				

LIC ELECTRONIC

AUTOPULSE 320-T3 208-240V

1				PP
2				
3				

LIC ELECTRONIC

AUTOPULSE 320-T1
15 **320 A** 400V 3~

with accessories:
4 m, 35 mm² 043817 + Alu 250 A, 3 m, air Ø 1.0 Ø 1.2 072138

069831



10 m³ (50L)

1 x

5 m

AUTOPULSE 320-T3
15 **320 A** 400V 3~

with accessories:
4 m, 35 mm² 043817 + Steel 250 A, 3 m, air Ø 1.0 072152 + Steel 250 A, 3 m, air Ø 0.8 072145 + Alu 250 A, 3 m, air Ø 1.0 Ø 1.2 072138

067615

AUTOPULSE 320-T3 208-240V
15 **320 A** 208>240V 3~ PFC

with accessories:
4 m, 35 mm² 043817 + Steel 250 A, 3 m, air Ø 1.0 072152 + Steel 250 A, 3 m, air Ø 0.8 072145 + Alu 250 A, 3 m, air Ø 1.0 Ø 1.2 072138

036970

2 x 4 m³ (20L)

3 x

OPTIONS

for AUTOPULSE 320-T3 (400V) only

SPOOLGUN TORCH

Ideal Alu

Ø 0,8

4m 041486

Motor inside

Ø 100

220 A • x 3

320 A • x 1

320 A • x 3

MADE IN FRANCE EN60974-1	50 / 60 Hz	A	Ø mm	min → max	SPOOLGUN	PUSH/PULL	200	Cooling system	Equipement d'origine Original equipment Originalausstattung Equipamiento de fabrica		EN60974-1 (40°C)		LxWxH cm / kg	Protected & compatible power generator (+/-15%)
									ELECTRONIC CONTROL	IA (60%)	X% (I2 max)			
AUTOPULSE 220-M3	230 V · 1~	8 m	16	0.6+1.2	10+220	OPTION	Air		ACIER : Type B 0.6 / 0.8 ACIER : Type B 0.8 / 1.0 ALU : Type B 1.0 / 1.2	150	220 A @ 20%	75 x 41 x 94 / 80	10 kVA	
AUTOPULSE 220-M3 208-240V	208>240 V · 1~	8 m	16	0.6+1.2	10+220	OPTION	Air		ACIER : Type B 0.6 / 0.8 ACIER : Type B 0.8 / 1.0 ALU : Type B 1.0 / 1.2	150	220 A @ 20%	75 x 41 x 94 / 80	10 kVA	

MADE IN FRANCE EN60974-1	50 / 60 Hz	A	Ø mm	min → max	SPOOLGUN	PUSH/PULL	200 / 300	Cooling system	Original equipment Equipement d'origine Originalausstattung Equipamiento de fabrica		EN60974-1 (40°C)		LxWxH cm / kg	Protected & compatible power generator (+/-15%)
									ELECTRONIC CONTROL	IA (60%)	X% (I2 max)			
AUTOPULSE 320-T1	400 V · 3~	5 m	16	0.6+1.2	15+320	OPTION	Air		ALU : Type B 1.0 / 1.2	260	320 A @ 35%	74 x 41 x 94 / 65.1	16 kVA	
AUTOPULSE 320-T3	400 V · 3~	5 m	16	0.6+1.2	15+320	OPTION	Air		ACIER : Type C 0.8 / 1.0 mm ALU : Type C 1.0 / 1.2	260	320 A @ 35%	75 x 40 x 94 / 82	16 kVA	
AUTOPULSE 320-T3 208-240V	208-240 V · 3~	5 m	25	0.6+1.2	15+320	OPTION	Air		ACIER : Type C 0.8 / 1.0 mm ALU : Type C 1.0 / 1.2	260	320 A @ 35%	74 x 41 x 95 / 82	16 kVA	

AUTOPULSE
INVERTER PULSE MIG 3

MANUAL TORCHES

- Torches manuelles - Brenner
- Antorcha - Lastoort - Tocha

CLASSIC



Flexible



CLASSIC GRIP



CONFORT GRIP

360°

FUME EXTRACTION

Fume Extraction Torches - Torches aspirantes - Rauchgas-Absaugbrenner - Antorcha con aspiración de humos



Complete systems (p. 121)



PUSH PULL

for AUTOPULSE



Light weight

Rollers - Galets - Drahtführungsrollen - Rollen - Rodillos - Wielen - Roletes
0.6/0.8/1.0 046290
0.8/1.0/1.2 038752

Connector Push Pull 10 pts 064393



SPOOL GUN

Special CAR BODY REPAIR MACHINES



∅ 100



COMPLETE TORCHES

X % 40°C, ArCo ₂	Steel/Stainless steel - Acier / Inox - Stahl/Edelstahl						ALU - Aluminium - Aluminio					PUSH PULL AIR	SPOOL GUN AIR
	AIR			LIQUID			AIR			LIQUID			
	150 A	150 A	250 A	250 A	350 A	300 A	150 A	250 A	250 A	350 A	300 A		
	A1 + A2	A1 + A2	B1 + B2	B1 + B2	D1 + D2	C1 + C2	A1 + A2	B1 + B2	B1 + B2	D1 + D2	C1 + C2	B1 + B2	A1 + A2
	M6 ∅0.8	M6 ∅1.0	M6 ∅0.8	M6 ∅1.0	M8 ∅1.2	M6 ∅1.2	M6 ∅0.8	M6 ∅1.0	M6 ∅1.2	M8 ∅1.2	M6 ∅1.2	M6 ∅1.2	M6 ∅0.8
	3 m	3 m	3 m	3 m	4 m	3 m	3 m	3 m	3 m	3 m	3 m	4 m	4 m
	063754	072121	072145	072152	063792	040694	063761	063785	072138	063808	040748	046283	041486
	3 m				4 m	3 m	3 m			3 m	4 m		
	082151				063778	040687	043275	041462	040724	Carbon liner 040731	043282		
	3 m				3 m	4 m				4 m			
	041424				040700	040946				040939	Carbon liner 040953		
	3 m				4 m	4 m							
	043268				040922	040557							
	3 m				3 m								
	043251				040540								

Anti-spatter spray (without silicone)

- Spray protecteur sans silicone
- Antihafspray (Ohne Silicon)

041806

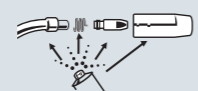

MIG torch stand with magnetic base

- Support torche magnétique

041653



CONSUMABLES - Consommables

Gas nozzles - Buses - Düsen - Tubo - Nippel - Bicos

A		Conical nozzle - Buse conique - Konische Düse
B		Spot welding - Pointage - Punktöse
C		Nail welding - Soude clou - Nagelschweißdüse
D		Special No Gas (isolated) - Isolée spéciale Sans gaz
E		Conical nozzle - Buse conique - Konische Düse

Torch liners - Gains
- Mantel - Funda
- Drahtseelen - Folha
(p. 103)

Tip adaptors & diffusers
- Supports tube contact & diffuseurs

A1		A2	
B1		B2	
C1		C2	
D1		D2	

Contact tips - Tubes contacts
- Kontaktröhre - Tubo de contacto
- Contactbuis - Pontas de contacto

A	
B	
C	

Tip adaptors & diffusers - Supports tube contact & diffuseurs

	Steel/Stainless steel - Acier / Inox - Stahl/Edelstahl				ALU - Aluminium - Aluminio				PUSH PULL		SPOOL GUN
	AIR		LIQUID		AIR		LIQUID		AIR		AIR
	150 A	250 A	350 A	300 A	150 A	250 A	350 A	300 A	150 A	250 A	150 A
	A1 (x5)	B1 (x5)	D1 (x3)	C1 (x3)	A1 (x5)	B1 (x5)	D1 (x3)	C1 (x3)	A1 (x5)	B1 (x5)	A1 (x5)
	042902	042995	043008	043589	042902	042995	043008	043589	042902	042995	042902
	A2 (x10)	B2 (x5)	D2 (x5)	C2 (x5)	A2 (x10)	B2 (x5)	D2 (x5)	C2 (x5)	A2 (x10)	B2 (x5)	A2 (x10)
	042988	042919	042926	043541	042988	042919	042926	043541	042988	042919	042988

Contact tips - Tubes contacts - Kontaktröhre - Tubo de contacto - Contactbuis - Pontas de contacto

	150 A	250 A	350 A	300 A	150 A	250 A	350 A	300 A	150 A	250 A	150 A
	A (x10) 041905	A (x10) 041905	—	A (x10) 041905	—	—	—	—	—	—	—
	A (x10) 041912	B (x10) 041950	C (x10) 041790	B (x10) 041950	B (x10) 041059	A (x10) 041059	—	B (x10) 041059	B (x10) 041059	B (x10) 041059	B (x10) 041059
	A (x10) 041929	B (x10) 041967	C (x10) 419803	B (x10) 041967	B (x10) 041066	B (x10) 041066	C (x10) 419766	B (x10) 041066	B (x10) 041066	B (x10) 041066	B (x10) 041066
	A (x10) 040144	B (x10) 041974	C (x10) 419810	B (x10) 041974	B (x10) 041073	B (x10) 041073	C (x10) 419773	B (x10) 041073	B (x10) 041073	B (x10) 041073	B (x10) 041073
	—	—	C (x10) 419827	—	—	—	—	—	—	—	—
	—	—	C (x10) 419834	—	—	—	C (x10) 041080	—	—	—	—
	—	—	C (x10) 040533	—	—	—	—	—	—	—	—

Gas nozzles - Buses - Düsen - Tubo - Nippel - Bicos

	150 A	250 A	350 A	300 A	150 A	250 A	350 A	300 A	150 A	250 A	150 A		
	53 mm ∅12 (x3) 041875	57 mm ∅15 (x3) 041882	84 mm ∅16 (x3) 041783	63.5 mm ∅12 (x3) 043534	53 mm ∅12 (x3) 041875	53 mm ∅16 (x3) 046214	57 mm ∅15 (x3) 041882	84 mm ∅16 (x3) 041783	63.5 mm ∅12 (x3) 043534	63.5 mm ∅17 (x3) 046221	53 mm ∅12 (x3) 041875	57 mm ∅15 (x3) 041882	53 mm ∅12 (x3) 041875
	53 mm (x1) 041851	—	—	—	—	—	—	—	—	—	—	—	—
	53 mm (x1) 041523	—	—	—	—	—	—	—	—	—	—	—	—
	(x1) 041868	—	—	—	—	—	—	—	—	—	—	—	—
	(x1) 043084	(x1) 040571	(x1) 040588	—	—	—	—	—	—	—	—	—	—

Boxes

- Coffrets - Verschleißteilebox
- Cajas - Kistjes - Estojos



	x 3		x 5		M6 - ∅0.6 x 5 M6 - ∅0.8 x 5 Alu - M6 - ∅0.8 x 5		x 3	=	MB 15 (150 A) 041226
	M6 - ∅0.6 x 5 M6 - ∅0.8 x 5 Alu - M6 - ∅1.0 x 5		M6 - ∅0.8 x 5 M6 - ∅1.0 x 5 Alu - M6 - ∅1.0 x 5		—		—	=	MB 15 / MB 25 077089
	x 5		x 3		M6 - ∅0.8 x 5 M6 - ∅1.0 x 5 Alu - M6 - ∅1.0 x 5		x 3	=	MB 25 (250 A) 041233
	x 2		x 3		M6 - ∅1.0 x 5 M6 - ∅1.2 x 5 Alu - M6 - ∅1.0 x 5 Alu - M6 - ∅1.2 x 5		x 2	=	MB 36 (350 A) 041417

CONSUMABLES - Consommables

TORCH LINERS - Gainses - Mantel - Funda - Drahtseelen - Folha

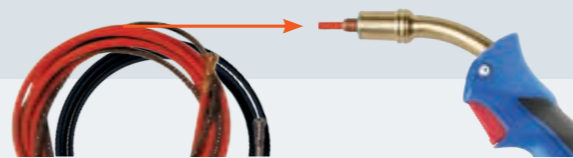

STEEL - Acier - Stahl - Acero - Staal - Aço			
Ø 0.6 / 0.8	3 m	041592	
	4 m	041837	
Ø 1.0 / 1.2	3 m	041608	
	4 m	041844	
	5 m	062276	
Ø 1.2 / 1.6	3 m	418417	
	4 m	418424	
Ø 1.6 / 2.4	4 m	040526	
	5 m	062290	

TEFLON			
Ø 0.6 / 0.8	3 m	041578	
	4 m	044050	
Ø 1.0 / 1.2	3 m	041585	
	4 m	044067	
	8 m	038677	
Ø 1.2 / 1.6	4 m	044074	



Guide gaine téflon pour motodévidoir 079601

CARBON			
Ø 0.6 / 0.8	4 m	039834	
	5 m	062306	
Ø 1.0 / 1.2	4 m	039827	
	5 m	062313	
Ø 1.2 / 1.6	4 m	039810	

PUSH PULL TORCH

Ø 1.0 / 1.2	8 m	038172	
-------------	-----	--------	--

ROLLERS - Galets - Vorschubrollen - Rollen - Rodillos - Wielen - Roletes

TYPE A

For : Carmig



Steel, Stainless steel - Acier, Inox	Ø 0.6 / 0.8	x1	042339
	Ø 0.8 / 1.0	x1	041189
Alu	Ø 0.8 / 1.0	x1	041196
Cored wire - Fil fourré	Ø 0.8 / 0.9	x1	046856
	Ø 0.9 / 1.2	x1	042346



TYPE B

For : Autopulse 220, Autopulse 320-T1, M1 GYS Auto, M3 GYS auto, T1 GYS Auto, T3 GYS Auto, E1/E2/E3 GYS Auto



Steel, Stainless steel - Acier, Inox	Ø 0.6 / 0.8	x1	042087
	x2	042353	
Alu	Ø 0.8 / 1.0	x1	042100
	x2	042360	
Cored wire - Fil fourré	Ø 1.0 / 1.2	x1	042179
	x2	046849	
Alu	Ø 1.2 / 1.6	x2	042384
	x1	042155	
Cored wire - Fil fourré	Ø 0.8 / 1.0	x2	042377
	x1	042186	
Alu	Ø 1.0 / 1.2	x2	040915
	x2	042391	
Cored wire - Fil fourré	Ø 0.9 / 1.2	x1	042131
	x2	042407	

TYPE C

For : Neopulse - Autopulse 320-T3



Steel, Stainless steel - Acier, Inox	Ø 0.6 / 0.8	x2	041738
	Ø 0.8 / 1.0	x2	042094
Alu	Ø 1.0 / 1.2	x2	042117
	Ø 1.2 / 1.4	x2	039780
Cored wire - Fil fourré	Ø 1.2 / 1.6	x2	041752
	Ø 0.8 / 1.0	x2	042148
Alu	Ø 1.0 / 1.2	x2	042162
	Ø 1.2 / 1.6	x2	041776
Cored wire - Fil fourré	Ø 0.9 / 1.2	x2	042124

NO GAS WELDING KIT Ø 0.9 - Kit soudage sans gaz Ø 0.9

041240



- Ø 0.9 1.0 / 1.2 (x1) Type A
- M6-Ø0.9 (x3)
- Isolated Nozzle No Gas - 150 A (x1)

For : Easymig 150/160/160XL Smartmig 142/152/162/3P/182/183, Multiplearl 200-2

SPECIAL MIG-MAG PLIER - Pince spéciale MIG/MAG - Spezial MIG/MAG Zange - Pinza especial MIG/MAG

PRO (x1)
041332

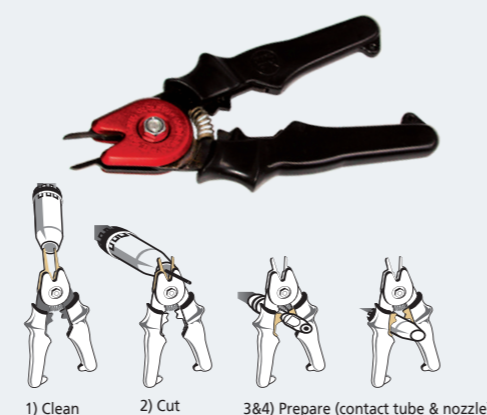

Anti-spatter spray (without silicone)
- Spray protecteur sans silicone
- Antihafspray (Ohne Silicon)

041806

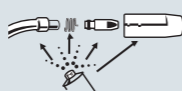

Torch gas flow-meter
- Débitmètre de bout de torche

053939



GAS CONNECTORS - Raccords gaz - Gasanschlüsse



x2
045712

Ø 8
Ø 7
x1
046245

x1
067936

Tuyau caoutchouc - Rubber hose
Ø 6.3 X 13 (EN ISO 3821)
1.5 m 066670
4 m 046269
x m 046276

WELDING WIRE REELS

- Bobines de fil - Drahtrollen - Rollos de hilo - Draadbobbijn - Bobines de fio

100 mm

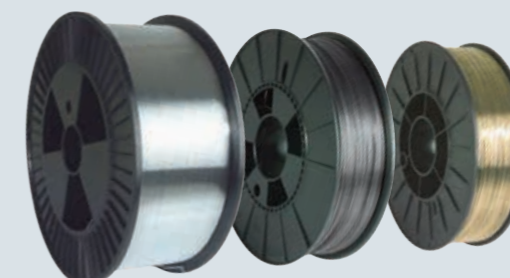

ECO
Ecological wire reel - Bobine écologique



STEEL - Acier - Stahl - Acero - Staal - Aço

SG2

Norms : AWS 5.18 : ER 70S-6 ; EN ISO 14341-A : G46 4MG3Si1 ; DIN 8559 : SG2

100 mm 0.9 kg	Ø 0.6	086593
	Ø 0.8	086609
200 mm 5 kg	Ø 0.6	086111
	Ø 0.8	086128
	Ø 1.0	086135
300 mm 15 kg	Ø 0.6	086166
	Ø 0.8	086227
	Ø 0.8 ECO	086272
EXCELLIUM 15 kg	Ø 1.0	086234
	Ø 1.0 ECO	086289
	Ø 1.2	086241
EXCELLIUM 15 kg	Ø 1.2 ECO	086296
	Ø 1.0 ECO	086302
EXCELLIUM 15 kg	Ø 1.2 ECO	086319

SG1

Norms : AWS 5.18 : ER 70S-3 ; EN ISO 14341-A : G42 2MG2Si1 ; DIN 8559 : SG1

200 mm 5 kg	Ø 0.6	086418
	Ø 0.8	086401

CrMo2Si

Norms : AWS 5.28 : ER 90S-B3 ; EN ISO 2195L-A : Cr CrMo2Si

300 mm 15 kg	Ø 0.8	086258
-----------------	-------	--------

UHSS

Norms : AWS ASME SFA-5.28 : ER 120 S-G ; EN ISO 12534 : G Mn4Ni2, 5CrMo

200 mm 5 kg	Ø 0.8	086203
----------------	-------	--------

Hardfacing - Rechargement Acier 60 HRC

Norms : EN 14700 : TZ Fe 2 ; DIN 8555 : MSG 6-CF-60

300 mm 16 kg	Ø 1.2 ECO	086173
-----------------	-----------	--------

Cored wire - Fil fourré - Fülldraht - Hilo tubular

Norms : AWS 5.20 : E71T-G5 ; EN ISO 17632-A T42 Z W N 1 H15

100 mm 0.9 kg	Ø 0.6	086425
	Ø 0.9	086104
200 mm 4.5 kg	Ø 0.9	086265
	Ø 1.0	086623
300 mm 15 kg	Ø 1.2	086630
	Ø 1.0	086388
	Ø 1.2	086395

Galva (G2Ti)

Norms : AWS 5.18 : ER 70S-2 ; EN ISO 14341-A : G42 2 M G2Ti ; DIN 8559 : SG2

200 mm 5 kg	Ø 0.6	086760
	Ø 0.8	086777

BRAZING - Brasage

CuAl8 HLE - UHTS (Boron Steel)

Norms : AWS 5.7 : ER CuAl-A1 ; EN ISO 14640 : S Cu 6100 ; DIN 1733 : SG-CuAl8

100 mm 1 kg	Ø 0.8	086692
200 mm 2 kg	Ø 0.8	077409
200 mm 5 kg	Ø 0.8	086661
	Ø 1.0	086197
300 mm 15 kg	Ø 1.0	086180

CuSi3 HLE - UHTS (Boron Steel)

Norms : AWS 5.7 : ER CuSi-A ; EN ISO 14640 : S Cu 6560 ; DIN 1733 : SG-CuSi3

100 mm 1 kg	Ø 0.8	086692
200 mm 2 kg	Ø 0.8	077393
200 mm 5 kg	Ø 0.8	086647
	Ø 1.0	086654
EXCELLIUM 5 kg	Ø 0.8	086210

STAINLESS STEEL - Inox - Edelstahl

CrNi (316LSi)

Norms : AWS 5.9 : ER 316L Si ; EN ISO 14343-A : G19 12 3 L Si ; DIN 8556 : SG X2 CrNiMo 19 12

200 mm 5 kg	Ø 0.8	086326
	Ø 1.0	086364
300 mm 15 kg	Ø 1.0	086371

CrNi (308LSi)

Norms : AWS 5.9 : ER 308L Si ; EN ISO 14343-A : G19 9 L Si ; DIN 8556 : SG X2CrNi 19 9

100 mm 1 kg	Ø 0.8	086616
200 mm 5 kg	Ø 0.8	086579
	Ø 1.0	086340
300 mm 15 kg	Ø 1.0	086357

ALUMINIUM

AlSi5

Norms : AWS 5.10 : ER 4043 ; EN ISO 18273 : S Al 4043-A ; DIN 1732 : SG-AlSi5

100 mm 0.5 kg	Ø 0.8	086685
200 mm 2 kg	Ø 1.0	086142
	Ø 1.2	086159

AlSi12

Norms : AWS 5.10 : ER 4047 ; EN ISO 18273 : S Al 4047 ; DIN 1732 : SG-AlSi12

100 mm 0.5 kg	Ø 0.8	086678
200 mm 2 kg	Ø 0.8	077140
	Ø 1.0	086067
300 mm 7 kg	Ø 1.2	086074
	Ø 1.2	086043

AlSi10Cu4

Norms : AWS 5.10 : ER 4145 ; EN ISO 18273 : S Al 41

200 mm 2 kg	Ø 1.2	073432
----------------	-------	--------

AlMg5

Norms : AWS 5.10 : ER 5356 ; EN ISO 18273 : S Al 5356 ; DIN 1732 : SG-AlMg5

100 mm 0.5 kg	Ø 0.8	086548
200 mm 2 kg	Ø 0.8	086555
	Ø 1.0	086562
300 mm 7 kg	Ø 1.0	086524
	Ø 1.2	086531
EXCELLIUM 7 kg	Ø 1.0 ECO	086487
	Ø 1.2 ECO	086494

After sales

Ø 200 & 300



Professional 71608

Ø 200 & 300



Industrial 71613

AlMg2.7Mn

Norms : AWS 5.10 : ER 5554 ; EN ISO 18273 : S Al 5554 ; DIN 1732 : SG-AlMg

200 mm 2 kg	Ø 1.2	086517
300 mm 7 kg	Ø 1.2	086500

Thickness measurement tools (x3)
- Jauges d'épaisseur (x3)
- Dickenessgeräte (x3)
071414

0.6 > 8 mm

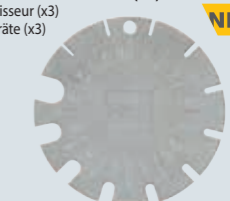



PLASMA CUTTING

EASYCUT K	101
EASYCUT	102
CUTTER	103



PLASMA

COMPRESSOR INSIDE • 1~



EASYCUT K25

230 V • 1 ~ 25 A Fe 8 mm
Al/CrNi 6 mm

P400 COMPRESSOR

TPT25, 4 m 068087 2 m, 10 mm²
068063

Youtube

COMPRESSOR COMPRESSOR INSIDE

ULTRA LIGHT & COMPACT

INTEGRATED AIR FILTER + AUTOMATIC DRAIN

PFC EN 61000-3-12 POWER FACTOR CORRECTION

Youtube

EASYCUT K35 PFC

230 V • 1 ~ 35 A Fe 15 mm
Al/CrNi 10 mm

P400 PFC AD COMPRESSOR

TPT35, 4 m 080775 2 m, 10 mm²
080768

TPT35, 4 m 2 m, 10 mm² Box TPT35 080782 UNIVERSAL 800 051331
080805

OPTIONS	Consumables					Boxes - Coffrets	Compas 040205	PLASMA 600 040298	Universal 800 051331
	TPT25	TPT35	for TPT25	for TPT35	for TPT35				
	x4	x4	x10	x10	x2	x10			
	040236	040182	040212	080799	040175	040168			
	x1	x1	x1	x1	x1	x1			
							x1		

MADE IN FRANCE CE NORM EN60974-1	50/60 Hz	A	I ₂	mm				INTEGRATED TECHNOLOGY					AIR SYSTEM			EN 60974-1 (40°C)			LxWxH cm / kg	Protected & compatible power generator (+/-15%)	
				Coupe max Severance cut	Coupe propre Clean cut	P400	PFC	AD	IP23	COMPRESSOR	min	ideal	max	160%	X% I ₂ max	100%	6.5 kW	7.5 kVA			
EASYCUT K25	230V 1~	16	10 → 25	8	6	6	4	■	—	—	—	■	included	15 A	35%	—	53 x 31 x 48 / 19	6.5 kW	7.5 kVA		
EASYCUT K35 PFC	230V 1~	16	10 → 35	15	10	10	8	■	■	■	■	■	included	26 A	30%	—	45 x 26 x 36 / 27	8 kW	10 kVA		



PLASMA

1~

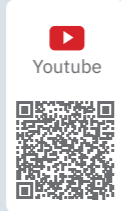

Plasma torch
TPT 25, 4m
068087

Plasma torch
TPT 35, 4m
080775

Plasma torch
TPT 40, 4m
060753

AD ANTI-DUST VENTILATION CORRIDOR

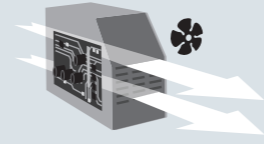

PFC + FV POWER FACTOR CORRECTION + FLEXIBLE VOLTAGE

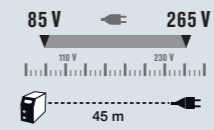

CNC COMPUTER NUMERICAL CONTROL

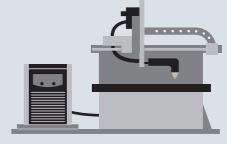

DIGITAL (PRESSURE SENSOR)

PFC EN 61000-3-12 FV FLEXIBLE VOLTAGE



IDEAL CARBODY REPAIR

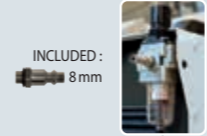

DIGITAL (PRESSURE SENSOR)

PFC EN 61000-3-12 FV FLEXIBLE VOLTAGE

DIGITAL (PRESSURE SENSOR)



EASycut 25

230 V • 1 ~ 25 A Fe 8 mm
Al/CrNi 6 mm

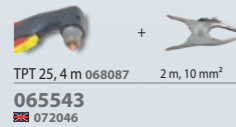

TPT 25, 4 m 068087 2 m, 10 mm²
065543
072046

EASycut 30 FV

110 → 230 V • 1 ~ 30 A Fe 15 mm
Al/CrNi 10 mm



TPT 30, 4 m 060753 2 m, 10 mm²
013858

EASycut 40

230 V • 1 ~ 40 A Fe 18 mm
Al/CrNi 15 mm

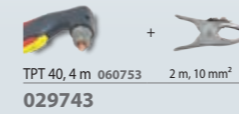

TPT 40, 4 m 060753 2 m, 10 mm²
029743

Cutter 45 CT

110 → 230 V • 1 ~ 45 A Fe 30 mm
Al/CrNi 20 mm



MT 70, 6 m 2 m, 10 mm² Box 20-50A 061613
062962



Consumables	MT25K	TPT25	MT35K	TPT35	TPT40
	x4 040182	x4 040236	x4 040229	x4 040182	x4 040236
	x10 040151	x10 040212	x10 040212	x10 080799	x10 040212
	x2 040175	x2 040175	x2 040175	x2 040175	x2 040175
	x10 040168	x10 040168	x10 040168	x10 040168	x10 040168
Boxes - Coffrets	039971	070721	039964	080782	039957

Trolley - Chariot	PLASMA 600	Universal 800	Jobsite XL
	040298	051331	039568
	↳ 39 x 58 x 62 cm / 8.2 kg	↳ 48 x 62 x 81 cm / 17.6 kg	↳ 60 x 59 x 115 cm / 18.4 kg
	↳ 63 x 30 x 11 cm / 8.8 kg	↳ 81 x 52 x 15 cm / 18.1 kg	↳ 66 x 47 x 20 cm / 19.6 kg



Compressed air cleaning filter for Plasma Cutter 40
- Filtre déshumificateur spécial Plasma 039728



Filter cartridge - Cartouche pour filtre 039735

CE NORME EN60974-1	EASycut / CUTTER	Voltage	I ₂	mm						INTEGRATED TECHNOLOGY					AIR SYSTEM			EN 60974-1 (40°C)		LxWxH cm / kg	Protected & compatible power generator (+/-15%)					
				Coupe max Severance cut		Coupe propre Clean cut		Perçage Piercing		P400	PFC	FV	GRID CUT	AD	IP23	CNC	min	ideal	max			I 60%	X% I2 max	100%		
				Fe	Al/CrNi	Fe	Al/CrNi	Fe	Al/CrNi																bar	bar
MADE IN GYS CHINA	EASycut 25	230V1~	16	10→25	8	6	6	4	—	—	—	—	—	—	—	—	—	2.5 bar	4.5 bar	6.5 bar	15 A	30%	10A	45 x 25 x 35 / 9.7	—	—
MADE IN FRANCE	EASycut 30FV	230V1~ 110V1~	16 32	10→30 10→30	15	10	10	8	—	—	—	—	—	—	—	—	—	2.5 bar	5 bar	9 bar	23 A 19 A	30% 25%	20 A 15 A	51 x 29 x 37 / 14.3	6.5 kW	6 kVA
MADE IN GYS CHINA	EASycut 40	230V1~	16	10→40	20	15	15	10	—	—	—	—	—	—	—	—	—	2.5 bar	4.5 bar	6.5 bar	10 A	20%	—	45 x 25 x 35 / 11.5	—	—
MADE IN FRANCE	Cutter 45CT	TPT 40	230V1~ 110V1~	16 32	15→45 15→30	20 15	15 10	10 8	8 —	6 —	—	—	—	—	—	—	—	5 bar	5.2 bar	7 bar	41 A 21 A	50% 25%	32 A 17 A	51 x 31 x 47 / 16.4	10.5 kW	8 kVA
		MT 70	230V1~ 110V1~	32 32	15→45 15→30	30 15	20 10	25 10	15 8	12 —	10 —	—	—	—	—	—	—	—	5 bar	5.2 bar	7 bar	41 A 21 A	50% 25%			



GYS

INVEST IN THE FUTURE



INDUCTION HEATING

1 200 - 22 000 kW

GYS DUCTION 106

COMBIDUCTION 107

POWERDUCTION 108

ACCESSORIES & CONSUMABLES 112



INDUCTION HEATING

CAR BODY

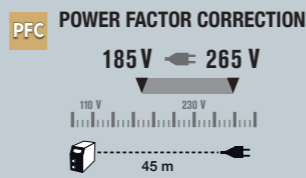

PACKS - GYSDUCTION AUTO									
	PROLINER AUTO 048775	COMPLETE AUTO 053380	COMPLETE AUTO+ 056978	MECA AUTO 048812	MECA AUTO+ 056961	BODY SHOP AUTO 048799	GLASS AUTO 048805	DENT REPAIR AUTO 054981	SMART REPAIR AUTO 079847
	✓	✓	✓	✓	✓	✓	✓	✓	✓
	✓	✓	✓	—	—	✓	✓	—	✓
	✓	✓	✓	—	—	✓	✓	—	✓
	✓	✓	✓	—	—	✓	1 box	—	✓
	✓	✓	✓	✓	✓	—	—	—	—
	✓	✓	✓	✓	✓	✓	—	—	✓
	✓	1 box	—	1 box	—	—	—	—	—
	✓	—	—	—	—	—	—	—	—
	3 boxes	—	—	—	—	✓	—	✓	—
	—	✓	—	✓	—	1 box	—	1 box	✓



GYSDUCTION AUTO

2 400 W 230 V • 1 ~

PFC AIR

CONSUMABLES

for	for	for
Protection (x5) + Colle - Stick 053854	Protection (x1) + Colle - Stick 059108	Protection (x10) + Colle - Stick 053847

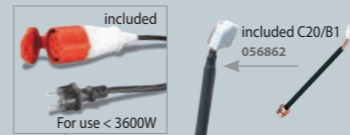

COMBIDUCTION AUTO 50LG

5 200 W 230 V • 1 ~

PFC LIQUID

065901



INCLUDED COMBIDUCTION

Glass - Décapage - Entfernen
053373

Decal - Décollage - Entkleben
053359

OPTIONS

Spiral inductor - Inducteur spirale - Spiralinduktor
054783

2.5 m 1.2 kW

800 mm 054813

800 mm 054868

SIDE	Ø	⊙	Code
	18 mm	≤ M8	054806
	24 mm	≤ M12	054790
	30 mm	≤ M16	055469

Complete with - Complétez avec - Vervollständigen mit :

SIDE	Ø	⊙	Code
	21 mm	≤ M10	079953
	27 mm	≤ M14	079960

FRONT	Ø	⊙	Code
	18 mm	≤ M8	079977
	21 mm	≤ M10	079984
	24 mm	≤ M12	079991
	27 mm	≤ M14	080003
	30 mm	≤ M16	080010

PDR : Paintless Dent Repair
- Débosselage sans peinture
- Lackschadenfreies Ausbeulen
054776

Licensed by BETAG innovation

3 m

Freezer spray - Spray refroidisseur
-50 °C
400 ml
(x 12)
048898

Adhesive for logo (x10)
051492

CE NORM. EN-60335/1	MADE IN FRANCE	Cable L (m)	Inductor	Heating	LxWxH cm / kg	LxWxH cm / kg	Protected & compatible power generator (+/-15%)						
								A	W	Freq. kHz	Tech. PFC	Liquid Cooling	⊙
GYSDUCTION AUTO	230V, 1~, 50/60 Hz	16 mini	2400	35+100	—	2	2.5	M10 → 1 s	2 mm → 5 s	Ø8 → 10 s	37 x 21 x 37 / 7.5	52 x 30 x 37 / 12.9	3 kW
COMBIDUCTION AUTO 50LG	230V, 1~, 50/60 Hz	25 mini	5200	20+80	71	8	3	M14 → 1 s	2 mm → 3 s 4 mm → 5 s	Ø10 → 10 s	46 x 43 x 75 / 60	v	6 kW



INDUCTION HEATING

1.2 → 5.2 kW

MAINTENANCE / MECHANIC / INDUSTRY

	10R	10R PRO
POWERDUCTION 10R	✓	✓
Flexible 800 mm 054813	✓	✓
Straight 800 mm 054868	✓	✓
SIDE		
Ø 18 mm ⊙ ≤ M8 054806	✓	✓
Ø 21 mm ⊙ ≤ M10 079953	✓	✓
Ø 24 mm ⊙ ≤ M12 054790	✓	✓
Ø 27 mm ⊙ ≤ M14 079960	✓	✓
Ø 30 mm ⊙ ≤ M16 055469	✓	✓
FRONT		
Ø 18 mm ⊙ ≤ M8 079977	✓	✓
Ø 21 mm ⊙ ≤ M10 079984	✓	✓
Ø 24 mm ⊙ ≤ M12 079991	✓	✓
Ø 27 mm ⊙ ≤ M14 080003	✓	✓
Ø 30 mm ⊙ ≤ M16 080010	✓	✓



	included	37LG S90	37LG S180/B3W
S90 058927	✓	✓	—
S180/B3W 067899	—	—	✓



1.5 m



2 m

1 200 W | 230V • 1~ | AIR

POWERDUCTION 10R
(5 inductors)
062504
068643
080966

POWERDUCTION 10R PRO
(12 inductors)
080195
080300

POWERDUCTION 37LG (S90) | POWERDUCTION 37LG (S180/B3W)

3 700 W | 230V • 1~ | * LIQUID
056992 | 080195 | 072510 | 080959

3 700 W | 230V • 1~ | * LIQUID
083387 | 083394

NEW

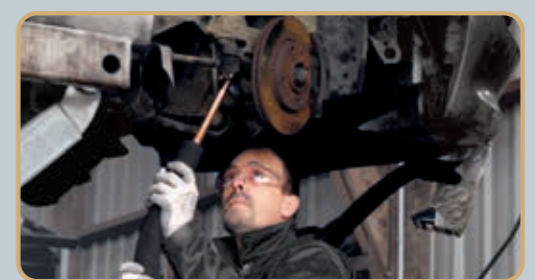
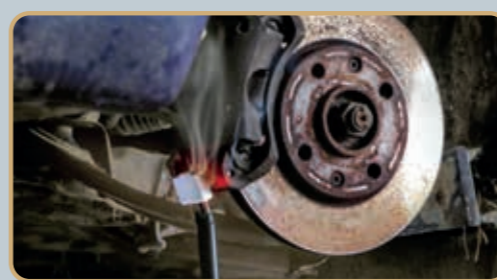
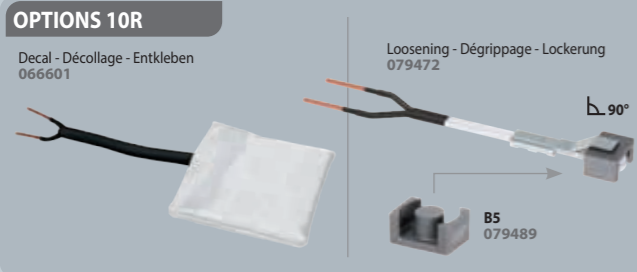

READY TO USE
Liquid included

READY TO USE
Liquid included

POWERDUCTION 39LG (C20/B1) | POWERDUCTION 39LG (S90) | POWERDUCTION 50LG

3 700 W | 230V • 1~ | * LIQUID
058583

3 700 W | 230V • 1~ | * LIQUID
080027

5 200 W | 230V • 1~ | * LIQUID
055599

MADE IN FRANCE	A	W	kHz	INTEGRATED TECHNOLOGY		Liquid Cooling	Cable L (m)		Heating			Protected & compatible power generator (+/-15%)	Dimensions	
				P400	PFC		Inductor	Inductor	Heating	Heating	L × W × H cm / kg		L × W × H cm / kg	
POWERDUCTION 10R / 10R PRO	230V, 1~ 50/60 Hz	10 mini	1 200	45+80	—	—	2	1.5	M10 → 1 s	2 mm → 5 s	Ø8 → 10 s	1.5 kW	062504 - 42 × 17 × 37 / 5.4	062504 - 21 × 10 × 15 / 3.3
POWERDUCTION 37LG	230V, 1~ 50/60 Hz	16 mini	3 700	15+30	—	—	1.51	2	M10 → 1 s	2 mm → 5 s	Ø10 → 15 s	4 kW	60 × 34 × 33 / 14.5	56 × 26 × 29 / 13
POWERDUCTION 39LG (C20/B1) / (S90)	230V, 1~ 50/60 Hz	16 mini	3 700	20+60	■	■	71	6	M12 → 1 s	2 mm → 5 s	Ø10 → 15 s	4 kW	058583 - 81 × 38 × 59 / 52	058583 - 46 × 36 × 70 / 46.5
POWERDUCTION 50LG	230V, 1~ 50/60 Hz	25 mini	5 200	20+60	■	■	71	8	M14 → 1 s	2 mm → 3 s 4 mm → 5 s	Ø10 → 10 s	6 kW	80 × 60 × 60 / 71	46 × 43 × 75 / 58



INDUCTION HEATING 11 → 22 kW

		NEW	
		110LG L90	110LG L20/B4
32L	064515	✓	✓
L90	059788	✓	—
L20/B4	067882	—	✓

		NEW	
		160LG L90	160LG L20/B4
32L	064515	✓	✓
L90	059788	✓	—
L20/B4	067882	—	✓



READY TO USE
Liquid included



READY TO USE
Liquid included



READY TO USE
Liquid included

	POWERDUCTION 110LG (L90)		POWERDUCTION 110LG (L20/B4)
11 000 W	400 V • 3~	11 000 W	400 V • 3~
* LIQUID		* LIQUID	
058590		083400	NEW

	POWERDUCTION 160LG (L90)		POWERDUCTION 160LG (L20/B4)
16 000 W	400 V • 3~	16 000 W	400 V • 3~
* LIQUID		* LIQUID	
057814		083417	NEW

	POWERDUCTION 110LG (L90) 208-240V
11 000 W	208-240 V • 3~
* LIQUID	
065246	

	POWERDUCTION 160LG (L20/B4) 208-240 V
16 000 W	208-240 V • 3~
* LIQUID	
065253	

OPTIONS

- Removable handle - Poignée de lance - Abnehmbarer Griff for POWERDUCTION 110 - 160 - 220 LG 068599
- Cooling liquid for POWERDUCTION
 - 2 L 082212
 - 5 L 062511
 - 10 L 052246
- Protection cover - Housse de protection - Schutzhaube for POWERDUCTION 160 - 220 LG 050853
- Protection cover - Housse de protection - Schutzhaube for POWERDUCTION 110LG 062733
- 055490

OPTION

Powerduction 160/220 LG over hanging arm-pulley
- Équilibrer Powerduction 160/220 LG

079441

t° POWER HEAT CONTROLLER

t° CONTROL
80>350°C (210>660°F)

5,5m

POWER HEAT CONTROLLER
061644

Included
T° sensors thermocouple type K x2

Compatibility
POWERDUCTION 110LG
POWERDUCTION 110LG 208-240 V
POWERDUCTION 160LG
POWERDUCTION 160LG 208-240 V
POWERDUCTION 220LG

OPTION

Pyrometer IR
for inductor L90

1.1 m
064119

MADE IN FRANCE	Cable L (m)	Freq.	Liquid Cooling	Cable L (m)	Heating		LxWxH cm / kg	LxWxH cm / kg	Protected & compatible power generator (+/-15%)				
					Inductor	Heating							
POWERDUCTION 110LG	400 V, 3~, 50/60 Hz	16 mini	11 000	20+60	71	5	4	M18 → 1 s	2 mm → 2 s 4 mm → 4 s	Ø10 → 7 s	42 x 42 x 76 / 66.5	59 x 80 x 60 / 86	15 kW
POWERDUCTION 110LG 208-240V	208-240 V, 3~, 50/60 Hz	35 mini	11 000	20+60	71	5	4	M18 → 1 s	2 mm → 2 s 4 mm → 4 s	Ø10 → 7 s	42 x 42 x 76 / 78	59 x 80 x 60 / 90	15 kW
POWERDUCTION 160LG	400 V, 3~, 50/60 Hz	32 mini	16 000	20+60	301	4	6	M20 → 1 s	2 mm → 2 s 4 mm → 4 s	Ø10 → 5 s	78 x 58 x 118 / 128	80 x 61 x 120 / 140	22 kW
POWERDUCTION 160LG 208-240V	208-240 V, 3~, 50/60 Hz	45 mini	16 000	20+60	301	4	6	M20 → 1 s	2 mm → 2 s 4 mm → 4 s	Ø10 → 5 s	78 x 58 x 118 / 113.5	80 x 60 x 120 / 126	22 kW
POWERDUCTION 220LG	400 V, 3~, 50/60 Hz	32 mini	22 000	20+60	301	4	6	M45 → 3 s	4 mm → 3 s 8 mm → 9 s	Ø10 → 4 s	70 x 60 x 120 / 98	80 x 60 x 132 / 139	22 kW
POWERDUCTION 220LG 10M	400 V, 3~, 50/60 Hz	32 mini	22 000	20+60	301	4	10	M45 → 3 s	8 mm → 9 s 4 mm → 3 s	Ø10 → 4 s	70 x 60 x 120 / 132.5	80 x 60 x 120 / 144.5	22 kW

SMALL Ø16

INDUCTORS

* = original equipment	S90 058927	S70 061569	S180 059269	S20/B1 (20°) 064874	S180/B1 064881	S180/B3W 067899
37 LG	✓*		✓			✓
39 & 50 LG			✓ with adapter 28S			
110, 160 & 220 LG			✓ with adapter 32S			

	S20/D20 078796	S90/D20 078871	S180/D20 069985
Ø 20	S20/D25 078802	S90/D25 078888	S180/D25 069992
Ø 25	S20/D30 078819	S90/D30 078895	S180/D30 070592
Ø 30	S20/D35 078826	S90/D35 078901	S180/D35 070608
Ø 35	S20/D40 078833	S90/D40 078918	S180/D40 070615
Ø 40	S20/D45 078840	S90/D45 078925	S180/D45 070622
Ø 45	S20/D50 078857	S90/D50 078932	S180/D50 070639
Ø 50	S20/D55 078864	S90/D55 078949	S180/D55 070646
Ø 55			
37 LG	✓ S20/D20-D35, S90/D20-D35, S180/D20-D35		
39 & 50 LG	✓ with adapter 28S		
110, 160 & 220 LG	✓ with adapter 32S		
Protection kit for L180/D inductors - Kit de protection pour inducteurs boucle 077386			

	S180 HEAT TUBE D37 078604	S180 HEAT TUBE D40 078611	S180 HEAT TUBE D50 078628
39 & 50 LG	✓ with adapter 28S		
110, 160 & 220 LG	✓ with adapter 32S		

DIFFICULT ACCESS ADAPTERS	
	<ul style="list-style-type: none"> 90°-S 082663 ✓ compatible with 180/B1 ✓ compatible with 180/B2 ✓ compatible with 180/B3W

ADAPTERS	
	<ul style="list-style-type: none"> 28S M28 Ø16 064485 32S M32 Ø16 064508
39 & 50 LG	✓ 28S M28 Ø16
110, 160 & 220 LG	✓ 32S M32 Ø16

Boxes - Boîtes		
<ul style="list-style-type: none"> 28S/B type W for 39LG & 50LG 072497 included: S20/B1 (x1), S180/B1 (x1), S180/B3 (x1), 28S (x1), B1 (x1), B3 (x1) 	<ul style="list-style-type: none"> 32S/B type W for 110LG, 160LG & 220LG 072503 included: S20/B1 (x1), S180/B1 (x1), S180/B3 (x1), 32S (x1), B1 (x1), B3 (x1) 	<ul style="list-style-type: none"> L box 065796 included: L70 (x1), L180 (x1)

Trolley for inductor for adapter 32L Chariot pour inducteur pour adaptateur 32L 075955	<p>4 to 8 wheels</p>
--	----------------------

Ferrites - Ferrites - Ferritaufsatz					
<ul style="list-style-type: none"> B1 053823 B1 (x5) 079380 	<ul style="list-style-type: none"> B2 053458 	<ul style="list-style-type: none"> B3 067875 	<ul style="list-style-type: none"> B4 053755 	<ul style="list-style-type: none"> B5 079489 	<ul style="list-style-type: none"> B1 056909 B1 (x5) 079397 B2 056916 B3 072527 B4 054844 Spiral 069701

Glue kit for inductor Kit de colle pour inducteur 075948	<ul style="list-style-type: none"> EA 9487 Colle-Stick bi-composants Power Epoxy 150°C 054851
--	---

LARGE Ø32

INDUCTORS

* = original equipment	L90 (90°) 059788	L70 (70°) 059771	L180 059795	L180/Spiral 065000	L20/B4 067882	L180/B4 079786	L20 Alu Glove 069114
39 & 50 LG				✓ with adapter 28L			
110, 160 & 220 LG	✓ with adapter 32L*		✓ with adapter 32L		✓ with adapter 32L*	✓ with adapter 32L	✓ with adapter 32L

Ø	Pre-heating - Préchauffe Heating - Chauffage	Pre-heating & Fretting - Préchauffage et Frettage		
		Ø 20°	Ø 90°	Ø 180°
Ø 60	✓	L20/D60 078956	L90/D60 079106	L180/D60 069923
Ø 70	✓	L20/D70 078963	L90/D70 079113	L180/D70 069930
Ø 80	✓	L20/D80 078970	L90/D80 079120	L180/D80 069121
Ø 90	✓	L20/D90 078987	L90/D90 079137	L180/D90 069947
Ø 100	✓	L20/D100 078994	L90/D100 079144	L180/D100 069954
Ø 110	✓	L20/D110 079007	L90/D110 079151	L180/D110 069961
Ø 120	✓	L20/D120 079014	L90/D120 079168	L180/D120 069978
Ø 130	✓	L20/D130 079021	L90/D130 079175	
Ø 140	✓	L20/D140 079038	L90/D140 079182	
Ø 150	✓	L20/D150 079045	L90/D150 079199	
Ø 160	✓	L20/D160 079052	L90/D160 079205	Production on request
Ø 170	✓	L20/D170 079069	L90/D170 079212	
Ø 180	✓	L20/D180 079076	L90/D180 079229	
Ø 190	✓	L20/D190 079083	L90/D190 079236	
Ø 200	✓	L20/D200 079090	L90/D200 079243	
39 & 50 LG		✓ with adapter 28L		
110, 160 & 220 LG		✓ with adapter 32L		

Pre-heating & Fretting - Préchauffage et Frettage	
> Ø 200 & < Ø 300	Production on request
110, 160 & 220 LG	✓ with adapter 32L

Brasing - Brasage	
* = original equipment	<ul style="list-style-type: none"> L90 BRAZ 16 Ø 1/2" / 16 mm 076907 L90 BRAZ 28 Ø 1" / 28 mm 076921 L180 BRAZ 16 Ø 1/2" / 16 mm 076914 L180 BRAZ 28 Ø 1" / 28 mm 076938
110, 160 & 220 LG	✓ with adapter 32L*

Protection kit for BRAZ inductors - Kit de protection pour inducteurs brasage 077515	
--	--

Protection kit for L180/D inductors - Kit de protection pour inducteurs boucle 077386	
---	--

ADAPTERS	<ul style="list-style-type: none"> 28L M28 Ø32 064492 	<ul style="list-style-type: none"> 32L M32 Ø32 064515
39 & 50 LG	✓ 28L M28 Ø32	
110, 160 & 220 LG	✓ 32L M32 Ø32	

Exchanger - Échangeur	
	<ul style="list-style-type: none"> L180R X Production on request
110, 160 & 220 LG	✓ with adapter 32L

COMPLETE Ø28 INDUCTORS

	C20/B1 056862	C180/B1 056879	C180/B2 056886
37 LG			
39 & 50 LG	✓*		✓
110, 160 & 220 LG			



TRUCK TOOLS & MOBILE LIFTS

TRUCK TOOLS

TROLLEY IW1	115
MULTITOOL TRUCK	115

CAR LIFTS

SPOT LIFT	116
NEW QUICK LIFT / AIR JACKS	118
ERGO LIFT	119
NEW MANUAL DOOR LIFT / WHEEL LIFT	120

TROLLEY IW1 / MULTITOOL TRUCK

TRUCK TOOLS

TROLLEY IW1
Impact wrench trolley -
Support de clé à choc

max 6.5 bar

max 20 kg

063136

OPTIONS

Huile hydraulique - Hydraulic oil
1l
053397

**Weight, vibrations & torque suppression -
Suppression du poids, des vibrations et du couple**



70 kg
95 cm
86 cm
86 cm
39 cm
75 kg
123 cm
79 cm

42°

90 cm (max)
30 cm (min)

Weight adjust - Effort réglable

Impact wrench - Clé à choc
max 20 kg

Fixation
36 x 36 mm
→ 44 x 44 mm

High dexterity - Liberté de mouvement

High maneuverability & stability - Grande maniabilité et stabilité



115

TRUCK TOOLS



MULTITOOL TRUCK

SAFE EN 14238 + A1

max 200 kg

067158

INCLUDED



Lifting tool for brake caliper - Outil de levage pour étrier de frein - Hebewerkzeug für Bremssattel

Brake caliper



Lifting tool for battery - Outil de levage pour batterie - Hebewerkzeug für Batterie

Truck batteries



Lifting tool for wheels - Outil de levage pour roues - Hebewerkzeug für Räder

SAFE EN 14238 + A1

90kg
103 > 186 cm
88.5 > 110 cm
101 > 130 cm
39 cm
95 kg
123 cm
79 cm

ULTRA COMPACT 103 cm

HEALTH CARE

90°



SPOT LIFT

MOBILE LIFTS

SPOT LIFT EASY

max Air 8 bar **SAFE EN 1494**
max 2.2 t

HEALTH CARE

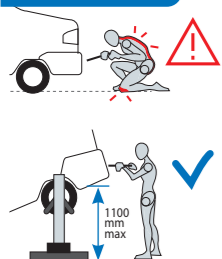

High stability - Haute stabilité

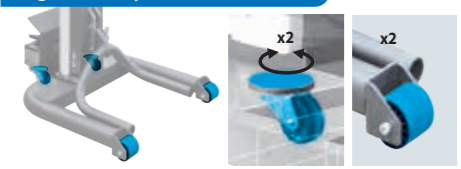

Included 220 bar 053588

SAFE EN 1494

SECURITY

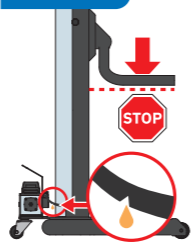

OPTIONS

Hydraulic oil 1L - Huile hydraulique 1L 053397



Rocker panel lifting tool - Outil de levage pour bas de caisse - Auflage für Seitenschweller 053236

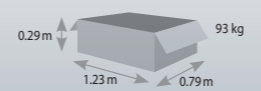

SPOT LIFT PRO

max Air 8 bar **SAFE EN 1494**
max 2.2 t

053557

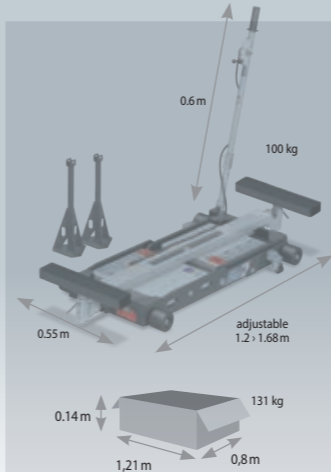

SAFE EN 1494



SPOT LIFT PRO MOB

max Air 8 bar **SAFE EN 1494**
max 2.2 t

055896

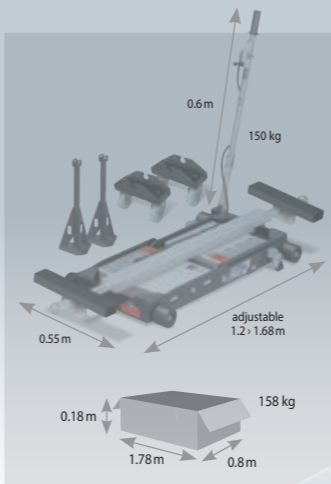

SAFE EN 1494

60 cm (max)
14 cm (min)

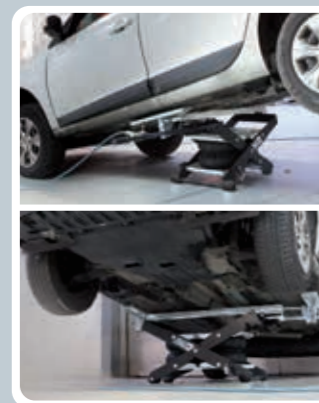

OPTIONS

Height adjuster for 4x4 & utility vehicles - Réhausseur pour 4x4 et utilitaires - Erhöhung f. 4x4 und Leicht-LKW



Pads - Patins for Audi & BMW (x 2) 053717

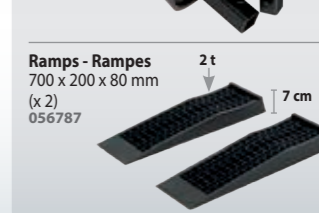

Ramps - Ramps 700 x 200 x 80 mm (x 2) 056787

AUTO ROLL



min 500 mm
max 1700 mm (AUTOROLL 1.0m)
max 2240 mm (AUTOROLL 1.55m)

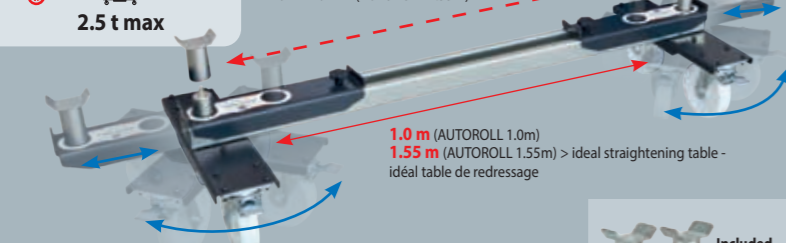

1.0 m (AUTOROLL 1.0m)
1.55 m (AUTOROLL 1.55m) > ideal straightening table - idéal table de redressement

AUTO ROLL 1.0 m / 1.2 t 059047

AUTO ROLL 1.55 m / 1.2 t 063839

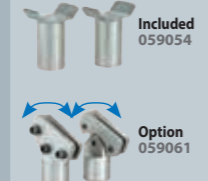

AFTER LIFT AUTO ROLL

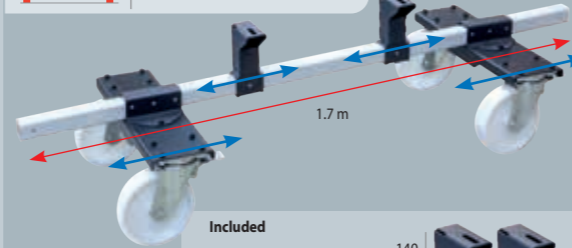
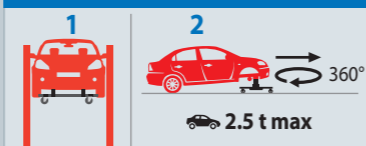

067967



WHEEL TROLLEYS - Tabourets de manutention - Radhocker

048768



26 cm max

MECHANICAL LIFTING JACKS - Chariots de manutention prise sous roue - Kfz-Montagelift, fahrbar

071995

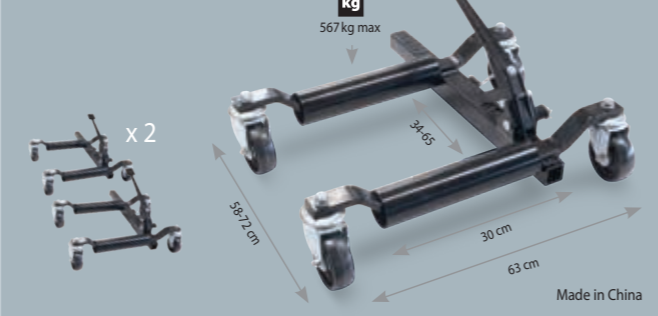

567 kg max (2x) 16 kg



Made in China



117

SPOT LIFT

MOBILE LIFTS

QUICK LIFT L520E

062184

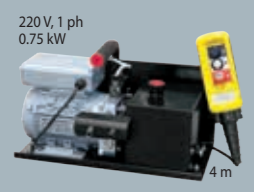

220 V, 1 ph
0.75 kW
Included Hydraulic oil 5 L
- Huile hydraulique 5 L
062160

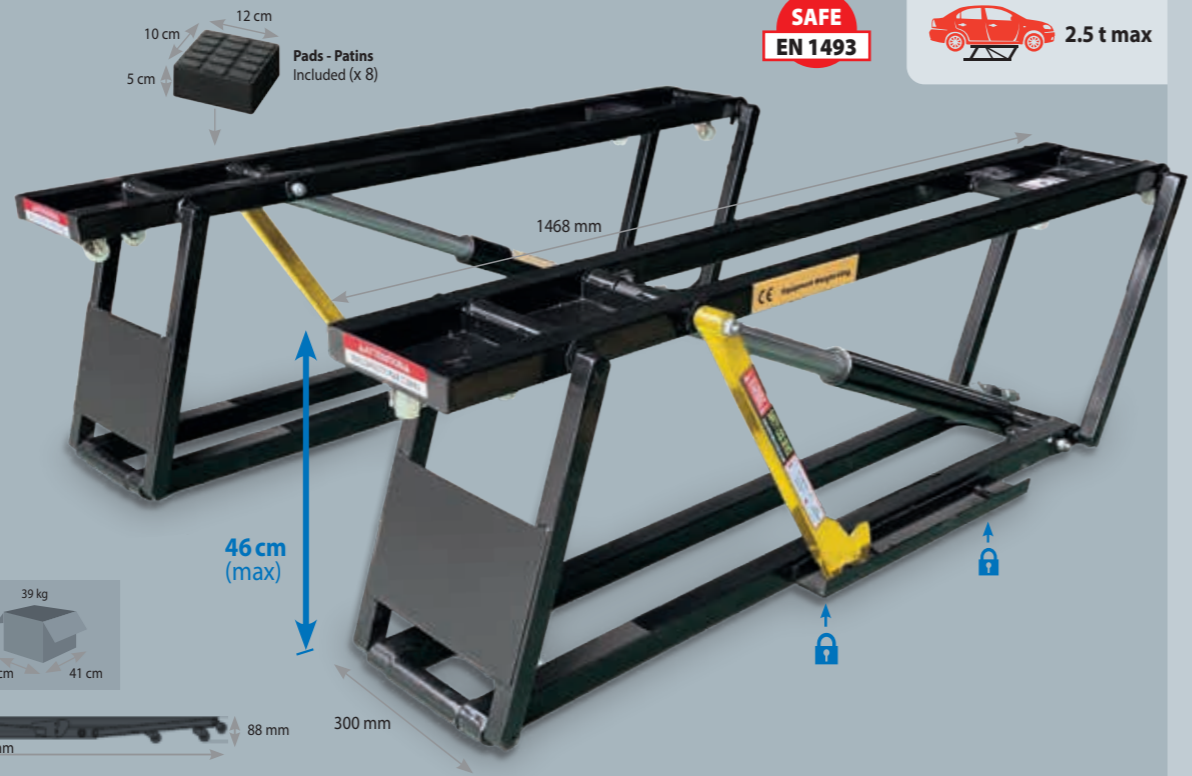

SAFE EN 1493 2.5 t max

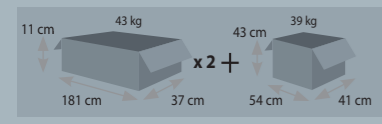
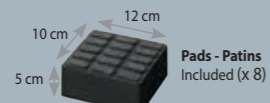

OPTIONS

- Extensions 1680 mm x 2 (066328)
- x4 Patins à rainures (071933)
- Pads for SUV x4 - Patins pour SUV x 4 (065017)
- Wall mount - Support mural (071926)

ERGO LIFT 1000 ROLL

Air 7-8 bars **SAFE EN 1493**
max 2.5 t



SAFE EN 1493

Handle for adjusting the automatic locking support arms - Poignée de positionnement des bras porteurs avec verrouillage automatique

included: (x4) 4 cm + (x4) 6 cm

95 cm (max)

30 cm x 23 kg x 49 cm x 37 cm (Wheels)

Wheel kit (076778) x 4

Pump included (082977) 29 cm x 8.7 kg x 38 cm x 18 cm

Easy connection

Hydraulic Safety

Security 100%

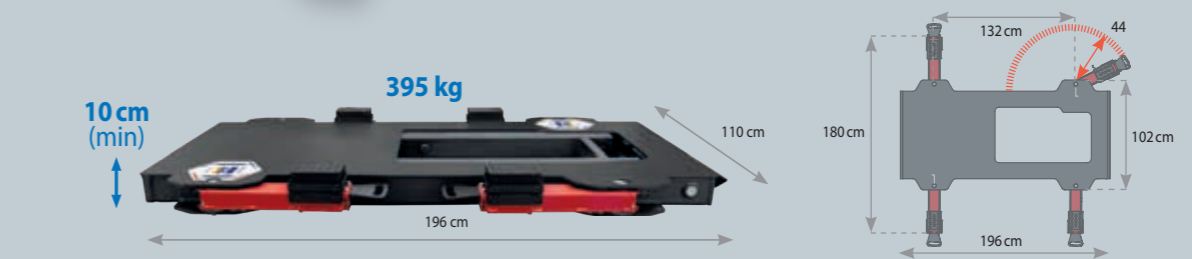

OPTIONS

- Pads for SUV x4 - Patins pour SUV x 4 (065017)
- Ergo Lift ramps x2 - Rampes Ergo Lift x2 (082717)
- Capacity: max 3.5 t
- Pack ERGO LIFT 1000 ROLL + wheels (076792)
- Pack ERGO LIFT 1000 ROLL + wheels + ramps (082984)

AIR JACKS

DOUBLE BAG AIR JACK 082878

60 x 52 x 14.5 cm
14.8 kg
SAFE EN 1494
12 kg
LIGHT & COMPACT

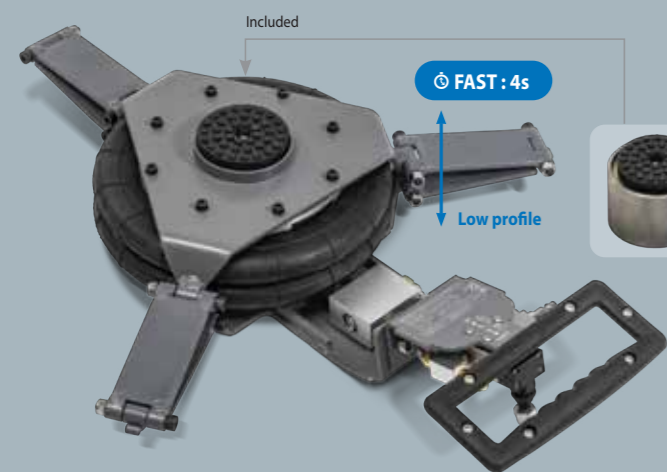

TRIPLE BAG AIR JACK 082885

Pressure: 8 bar (116 PSI)
Weight 14 kg
62 x 56.5 x 18 cm
17.8 kg
SAFE EN 1494
14 kg
LIGHT & COMPACT

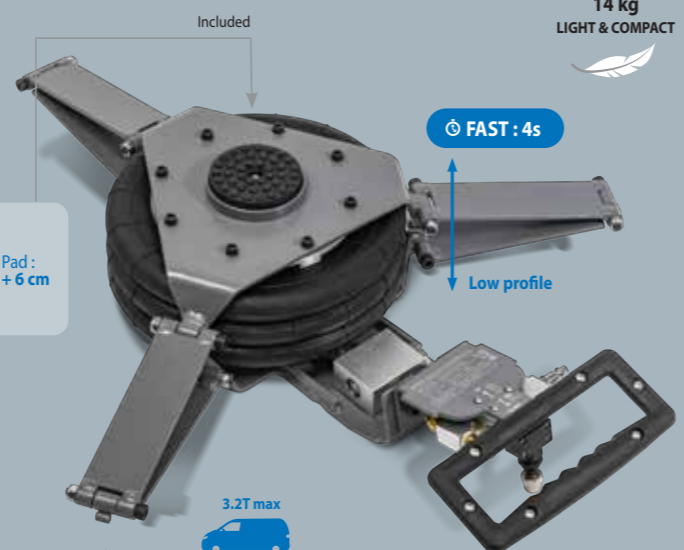

NEW 06/2024

NEW 06/2024

MANUAL DOOR LIFT

Ergonomic door handling trolley
 - Support Pro ergonomique de manutention de portière
 - Ergonomische Türhandhabungsunterstützung
 082670

Manufactured by GYS = SUPER PRO

117 x 28 x 27 cm
 40 kg

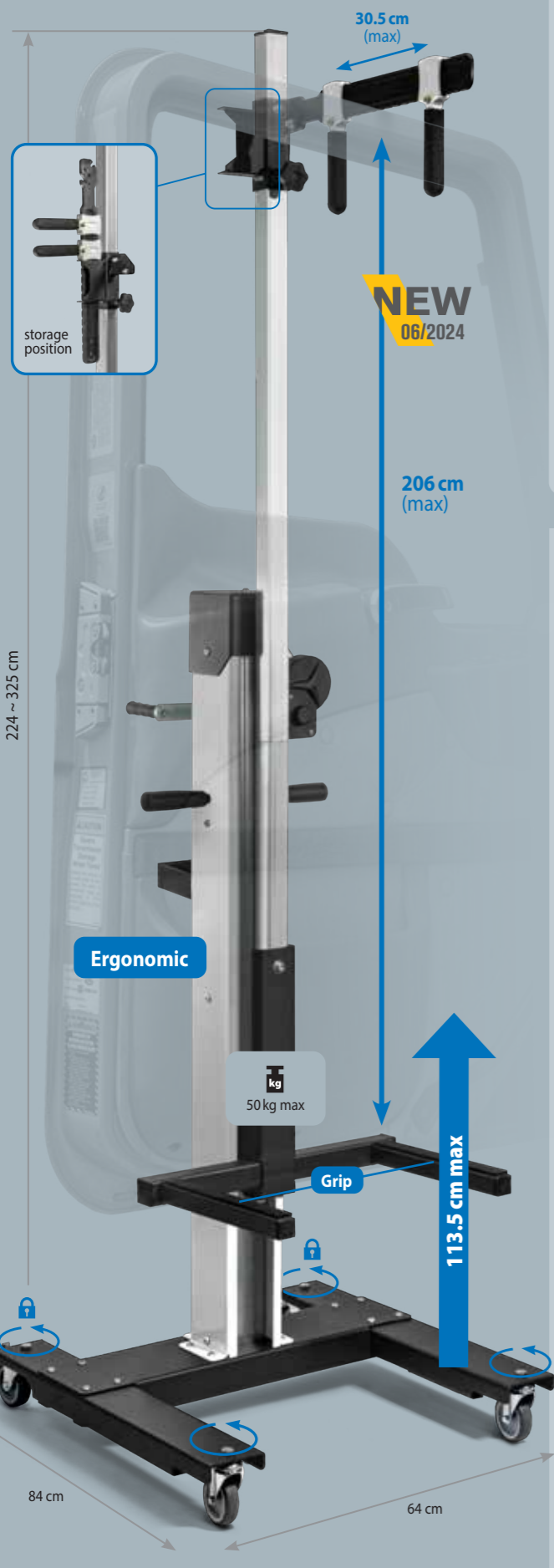

Option

Wide door accessory
 - Accessoire pour portière large
 - breites Türzubehör
 082700

NEW



MANUAL WHEEL LIFT

Wheel lift trolley
 - Lève roue à treuil
 - Radmontage-Heber
 061385

Manufactured by GYS = SUPER PRO

min: R13 / 135 / 65
 max: R22 / 300 / 35
 40 kg max

117 x 28 x 27 cm
 42 kg

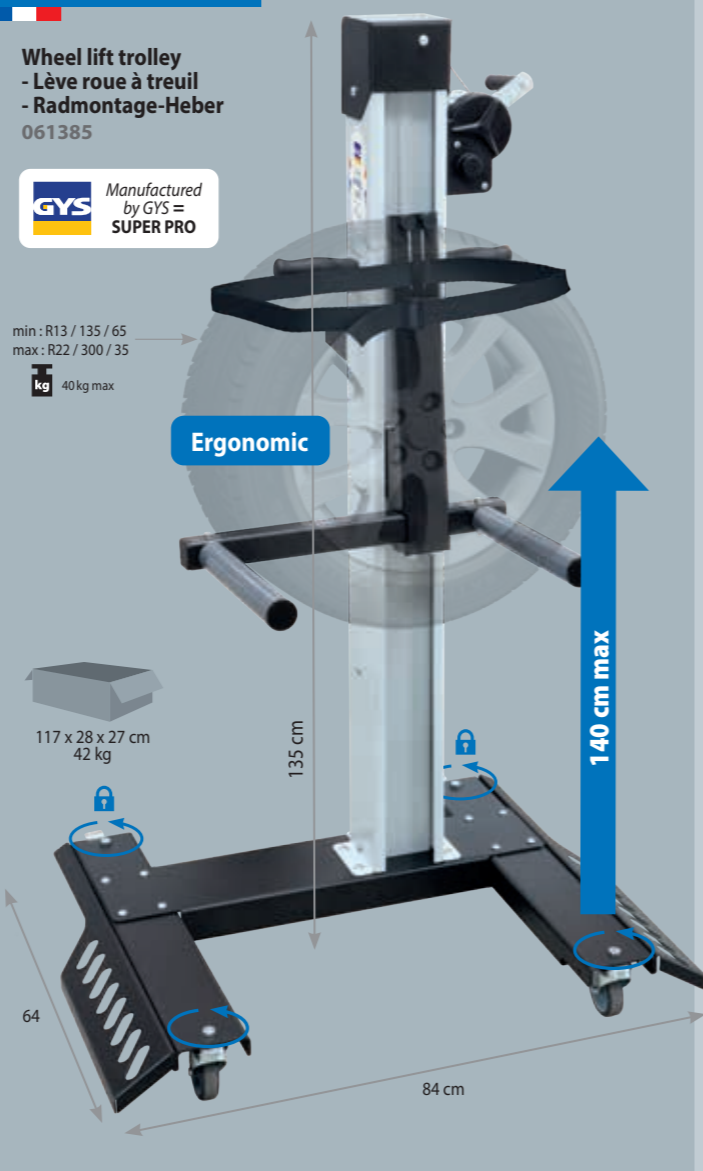

+

ACCESSORIES

WELDING HELMETS	122
FUME EXTRACTION	125
WINDSCREEN REPAIR	126
BUMPER REPAIR	128
HAND TOOLS	130
PNEUMATIC TOOLS	134
WORKING LIGHTS	136
SANDING & DUST EXTRACTION	138
WORKING SUPPORTS	140
ELECTRIC VEHICLES	144
SAFETY PROTECTION	146

HELMETS TECHNOLOGIES

Teinte initiale - Initial shade

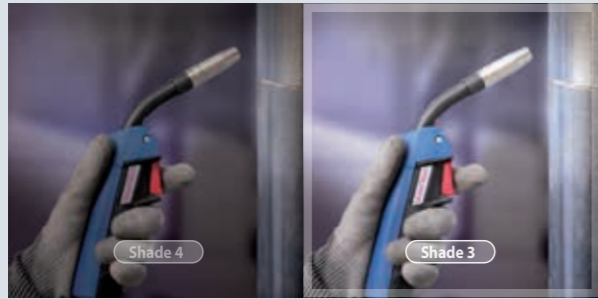

Classic

ULTRA CLEAR

Spectre de couleur - Spectrum view

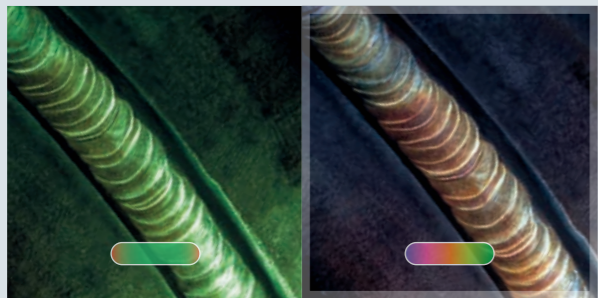

Classic

TRUECOLOR

Classification - X=/X=/X=/X=

1/1/1/1 = PERFECT QUALITY

(1) Optical quality (distortion). (2) Light diffusion (contrast). (3) Variation of light transmission (homogeneities of the dark shade). (4) Angular light (diagonal light ray filter).

(1) Qualité optique (distorsion). (2) Diffusion de la lumière (contraste). (3) Variation de la transmission lumineuse (homogénéités de la teinte foncée). (4) Lumière angulaire (filtre de rayons lumineux diagonaux).

Headgear - Serre-tête



Simple

Multi

Multi Pro

Multi Premium

Comfortable back

WELDING HELMETS

9-13

IDEAL



GYSMATIC 9-13 G
043909



◀ 100 x 60 mm | □→■ 0.08 ms

GRIND + (1/1/1) x 4 TRUECOLOR

WELDING HELMETS

5-9/9-13



Multi Premium



ALIEN XXL +
068698



◀ 100 x 93 mm

□→■ 0.08 ms

GRIND + (1/1/1) x 4 ULTRA CLEAR 3 TRUECOLOR

Body repair recommended



Multi Premium



GYSMATIC AUTO PRO
082809

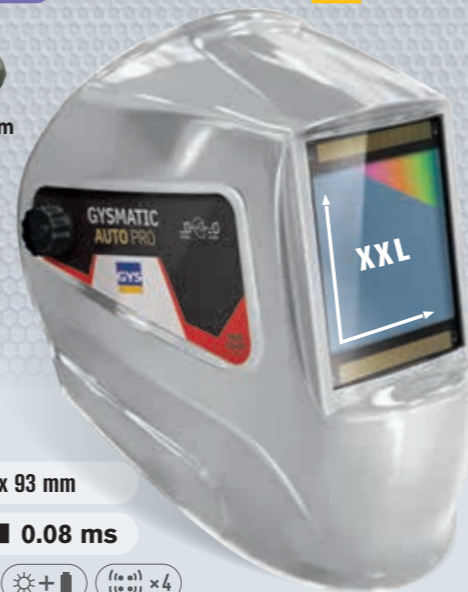

◀ 100 x 93 mm

□→■ 0.08 ms

GRIND + (1/1/1) x 4 CLASS 1/1/1/1 ULTRA CLEAR 3 TRUECOLOR

COMING SOON



Multi Pro



GYSMATIC 5-13 G
XXL
037236



◀ 100 x 93 mm

□→■ 0.04 ms

GRIND + (1/1/1) x 5 ULTRA CLEAR 2 DIGITAL TRUECOLOR

DIGITAL MEMORY & REGULATIONS ELECTRONIC

PANORAMIC

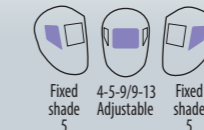

Fixed shade 5

4-5-9/9-13 Adjustable

Fixed shade 5



APOLLO + 3/5-13 G
068681



◀ 100 x 67 mm

□→■ 0.08 ms

GRIND + (1/1/1) x 4 PANORAMIC CLASS 1/1/1/1 ULTRA CLEAR 3 TRUECOLOR



Multi Premium

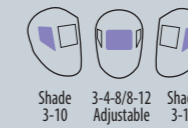

Shade 3-10

3-4-8/8-12 Adjustable

Shade 3-10



PANORAMIC 3XL
037281



◀ 114 x 85 mm

□→■ 0.04 ms

GRIND + (1/1/1) x 4 PANORAMIC ULTRA CLEAR 3 CLASS 1/1/1/1 ULTRA CLEAR 3 TRUECOLOR

OPTIONS



Carry bag for helmet welding - Sac pour masque de soudage
043299



066656



Antiperspirant-headband - Bandeau anti-transpiration
043466 for Multi Premium, Multi Premium Pro, Multi, Simple
062627 for Multi Pro
070844 for Gysmatic 9/13 Air, Gysmatic 5/13 Air XXL



Magnifying glass - Loupe for Zeus, Ergotech & Alien True Color
x1
zoom x2 042780
zoom x3 064140

LENSES - Verres - Schutzgläser

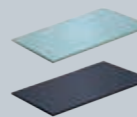

Code	Part No.	Dimensions	Part No.
114 x 133 (x10)	043893	G : 106 x 66 (x10)	043886
114 x 133 (x10)	043893	104 x 96 (x5)	043596
114 x 133 (x10)	043893	106 x 89,5 (x10)	046825
114 x 133 (x10)	043893	103.7 x 69.5 (x5)	077102
390 x 150 (x3)	037311	special kit (x1)	037304

Model	Shade	Response Time	Grind	Class	True Color	HF	Delay	Sensitivity	Dimensions	Weight	Mask Brand
GYSMATIC 9-13 G	4-9>13	0.08 ms	GRIND	1/1/1/1	TRUECOLOR	✓	0.1 > 0.9s	4 HIGH SENSITIVITY	XL: 100x60 mm	580 g	Gys
GYSMATIC ALIEN XXL + GYSMATIC AUTO PRO	3-5>9/9>13	0.08 ms	GRIND	1/1/1/1	TRUECOLOR	✓	0.15 > 0.8 s	4 HIGH SENSITIVITY	XXL: 100x93 mm	540 g	Gys
GYSMATIC 5-13 G XXL	2-4>9/9>12	0.04 ms	GRIND	1/1/1/1	TRUECOLOR	✓	0.06 > 1.2 s	5 HIGH SENSITIVITY	XXL: 100x93 mm	550 g	Gys
APOLLO + 3/5-13 G	3-5>9/9>13 + 2x: 5	0.08 ms	GRIND	1/1/1/1	TRUECOLOR	—	0.15 > 0.8 s	4 HIGH SENSITIVITY	XL: 100x67 + 2x103.7x69.5 mm	585 g	Gys
PANORAMIC 3XL	3-4>8/8>12 + 2x: 3>10	0.04 ms	GRIND	1/1/1/1	TRUECOLOR	✓	0.15 > 0.8 s	4 HIGH SENSITIVITY	114x85 + 2x(68x80) mm	610 g	Gys

HELMETS VENTILATED

IDEAL



DIGITAL MEMORY & REGULATIONS ELECTRONIC



GYSMATIC 3/9-13 G AIR
0465727
069602

100 x 60 mm

0.08 ms



GYSMATIC 5-13 G AIR XXL
047846
028852

100 x 83 mm

0.1 ms



included with GYSMATIC 5/13 G AIR XXL

Filtration class EN 12941 : TH2 P R SL
Air 165 / 200
220 L/min
Battery included

OPTION Filter TH3
065734



Battery charger
037472
028869



Battery included
037465



038424 x1



038417 x5

LENSES - Verres - Schutzgläser

			TRUE COLOR	HF	DELAY								L x W x H cm / g	MASK BRAND	
114 x 133 (x10)	043893	G: 106 x 66 (x10)	043886	GYSMATIC 3/9-13 G AIR	3-9>13	0.08 ms	✓	0.10>0.90 s	1/1/1/2	4 HIGH SENSITIVITY	XL : 100x60 mm	✓	Simple	28 x 25 x 28 / 1230	Gys
114 x 133 (x10)	043893	106 x 89,5 (x10)	046825	GYSMATIC 5-13 G AIR XXL	4-5>9 / 9>13	0.10 ms	✓	0.1 > 0.9 s	1/1/1/1	4 HIGH SENSITIVITY	XXL : 100x83 mm	✓	Multi Pro	27 x 25 x 28 / 1000	Gys

FUME EXTRACTION SYSTEMS - Aspirateurs de fumée - Rauchgasabsauggerät

UNI 2.0 RE

- 400V 3~
- 50 Hz
- 1100 W
- 1500 m³/h max
- arm 3 m
- no plug
- 100 kg
- extraction 0.5 m/s

122 x 67 x 145 cm / 111.5 kg

061545



Ø 150 mm

Included
Pré filtre, treillis Aluminium
Class of filtration G3 EN 779
+ **Filtre - Coal Filter EPA E12**
EN 779, Filtration >99.5 %
046467

Options
Filtre à charbon actif -
Coal filter
✓ UNI 2.0 RE
064522

EVO 2.1 RE

- 230V 1~
- 50 Hz
- 1100 W
- 1200 m³/h max
- occasional
- arm 3 m
- included
- 85 kg

96 x 95 x 162 cm / 114 kg

061552



Ø 150 mm

Patented - Breveté

792 mm

347 mm

Included
Pré filtre, treillis Aluminium
Class of filtration F15 G2 EN 779
+ **Filtre - Coal Filter HEPA H13**
EN 779, Filtration >99.95%
046498

FUME EXTRACTION TORCHES - Torches aspirantes - Rauchgas-Absaugbrenner - Antorcha con aspiración de humos



BINZEL

	Steel/Stainless steel - Acier/Inox - Stahl/Edelstahl			
	AIR		LIQUID	
	150 A	250 A	350 A	500 A
original equipment	M6	M6	M8	M8
Ø	Ø 0.8	Ø 1.0	Ø 1.2	Ø 1.2
X % 40°C - ArCO ₂	150A - 60%	200A - 60%	290A - 60%	380A-100%
GRIP	GRIP	GRIP	GRIP	GRIP
L	3m	3m	4m	4m
Ref.	043251	040540	040557	040564

For fume Extraction Torches - Pour torches aspirantes

BINZEL
073715



- 230V / 1 ~, 1100 W
- 230 m³/h max
- 190 mbar max
- 25 kg, 590 x 425 x 825 mm
- 76 db
- Filter auto cleaning system - Système de nettoyage automatique du filtre - Automatische Filterabreinigung

Filtre Classe M, EN 60335-2-69

included : 5 m, Ø50



External evacuation Ø50 (hose not included)
Évacuation extérieure Ø50 (tuyau non inclus)

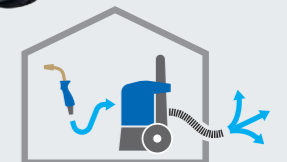

PROFESSIONAL BOX SET FOR WINDSCREEN REMOVAL - Coffret de découpe pare-brise
- Frontscheiben-Trennsystem für Akkuschrauberbetrieb

MADE IN
HIGH
QUALITY
GERMANY

057654

included
Axe enrouleur
068100

included
65 m
resistance 170 kg
Ø 0.79 mm
058125

optional
65 m
resistance 190 kg
Ø 0.92 mm
069275



OSCILLATING PNEUMATIC SAW FOR WINDSCREEN REMOVAL - Couteau pneumatique de découpe pare-brise
- Druckluft-Trennmesser für Windschutzscheiben

057623



Included
57 mm
057845

90 mm
057852

8 mm
057876

35 mm
057838

U
36 mm
057869

REMOVAL TOOL FOR WINDSCREEN WIPER ARMS - Extracteur d'essuie-glace - Wischerarm-Abzieher

UNIVERSEL
057630



30 mm
max

EXPERT

Accès difficile
- Difficult access
057647



40 mm
max



WINDSHIELD CUTTING KIT - Système de découpe pare-brise à cliquet
- Set zum Lösen von Windschutzscheiben

054738

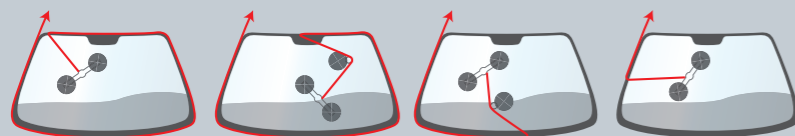

DASHBOARD PROTECTOR - Protections tableau de bord
- Armaturenbrett Schutz

053120

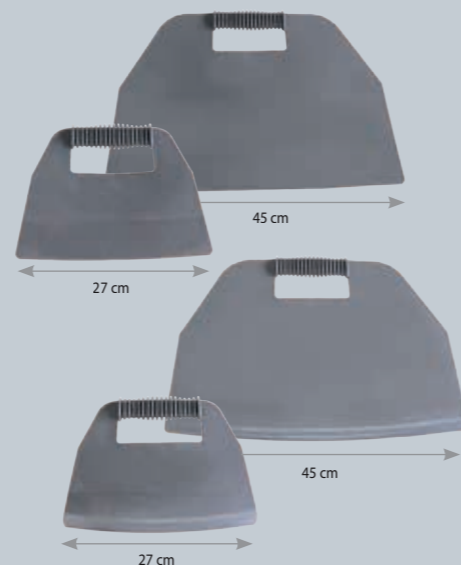

WINDSHIELD CUTTING TOOL - Outil découpe pare-brise
- Windschutzscheiben Demontage-Set

051935



WINDSCREEN JOINT-CUTTING KIT - Kit découpe joint de pare-brise - Scheibentrenn-Werkzeug-Set

051898



Corde à piano torsadé (22 m)
- Windscreen seal cutting wire
(twisted)
- Piano-Schneiddraht, gedreht,
22 m Rolle

051911

Corde à piano carré (50m)
- Windscreen seal cutting wire
(square)
- Vierkant-Draht,
50 m Rolle

051881

SUCTION LIFTING PADS - Ventouses - Saugnapfwerkzeug für Spiegelgläser

056695



Ø 70 mm



051966



x2

x6
057609

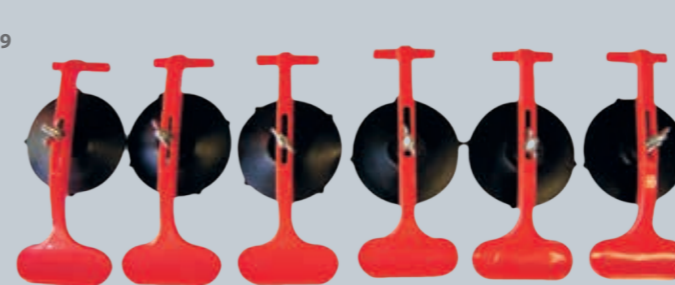

COMPRESSED AIR POLISHER - Renov'Polycarbonate - Druckluftpolierer

Complete pack

1 orbital sander
+ 1 polisher
- 1 ponceuse orbitale
+ 1 lustreuse

052086



2 SPEED

+

+

+

+

+

+

+

+

+

+

+

+

+

+

+

+

+

+

+

+

+

+

+

+

+

+

+

+

+

+

+

+

+



Ø 76

P 500 (x 10)
P 800 (x 10)
P 1500 (x 10)
P 3000 (x 10)

P 500 x 50 052017
P 800 x 50 052024
P 1500 x 50 052031
P 3000 x 50 052048

polisher Ø75
058224

052055

052062

052079

sander Ø75
057494

052086

052086

052086

052086

052086

HOT STAPLER FOR BUMPER REPAIR - Agrafeuse pour réparation pare-chocs - Stoßstangen Reparatur Kit

052925

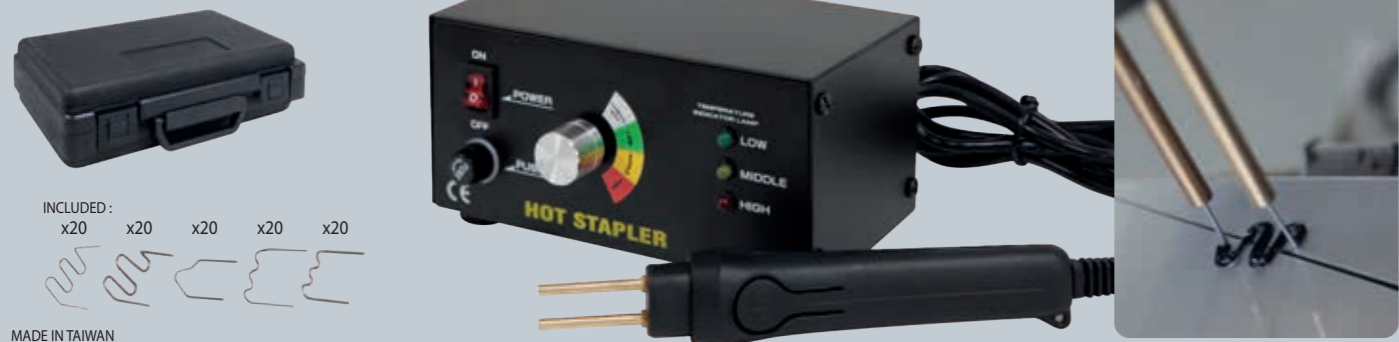

INCLUDED:
x20 x20 x20 x20 x20

MADE IN TAIWAN

PORTABLE
Battery operated - Sur batterie
058118

included
Li-ion battery 3.7V
048669
included adapters:
EUR, UK, USA & AUS

Charger included
048652

MADE IN TAIWAN



INCLUDED:
Ø 0.6, x100 Ø 0.8, x100
Ø 0.6, x100

Staples - Agrafes	V	U	N	W	M
	Inside corner - Angle interne étroit Ø 0.7 mm	Crack alignment - Alignement de fissure Ø 0.7 mm	Large crack - Fissure importante Ø 0.7 mm	Internal angle - Angle interne Ø 0.7 mm	External angle - Angle externe Ø 0.7 mm
	x 100 047990	x 100 047983	x 100 047976	x 100 047969	x 100 047952
052413	= x 50	+ x 50	+ x 50	+ x 50	+ x 50

PLASTIC WELDING STATION - Station de soudage des plastiques - Kunststoff-Schweißset

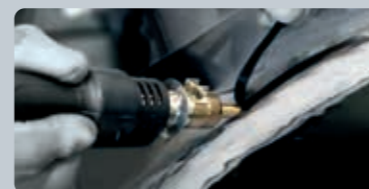

320 W - 230 V, 1-50 Hz
Temperature: 160 < 480°C
▲ 3.4 kg
Length of hose: 1 m
Air flow: 24 l/min

Station seule
- Station only
064072



Ø 5 mm
066694
Ø 8 mm
066700

plastic rods - baguettes plastique 440 mm	PP / EPDM	▲ 4 mm	x 10	066304
		■ 6 mm	x 10	067622
ABS	▲ 4 mm	x 10	071322	
	■ 8 mm	x 10	071339	

Station	PP/EPDM			Pressure wheels	Mini milling machine	Scraper
	4mm (x10)	6mm (x10)	8mm (x10)			
064072	✓					
070974			✓			

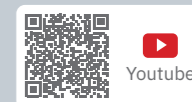

WELDING KIT FOR PLASTICS - Kit de soudage des plastiques - Kunststoff-Schweißset



1 600 W - 230V - 50/60 Hz
max. 230 l/min
▲ 1.3 kg / -L- Ø100 x 300mm,
poignée Ø 56mm.

057678



PIERCING KIT FOR BUMPER SENSORS - Coffret de perçage pare-chocs pour détecteurs - Lochwerkzeug für Stoßfänger



PRO +
059139

➔ Ø 17-18-18,2
19-20-22,5-24
26-26,7-32 mm



FREEZER

Freezer spray
- Spray refroidisseur

-50 °C

400 ml

(x 12)
048898



TOOL FOR REMOVING BUMPER - Outil de déclipsage pare-chocs



076518



x15
076525

HAND SEAMER FOR PLASTIC REPAIR
- Pince de serrage pour réparation des plastiques

082014



MULTI-CLIP PLIER
- Pince multi-clip

083813



DURABLE
HIGH-CARBON
STEEL



BRAZING AUTOMOTIVE PLASTICS REPAIR KIT
- Coffret de réparation des plastiques automobiles - Kunststoff
Reparatur Set

052932

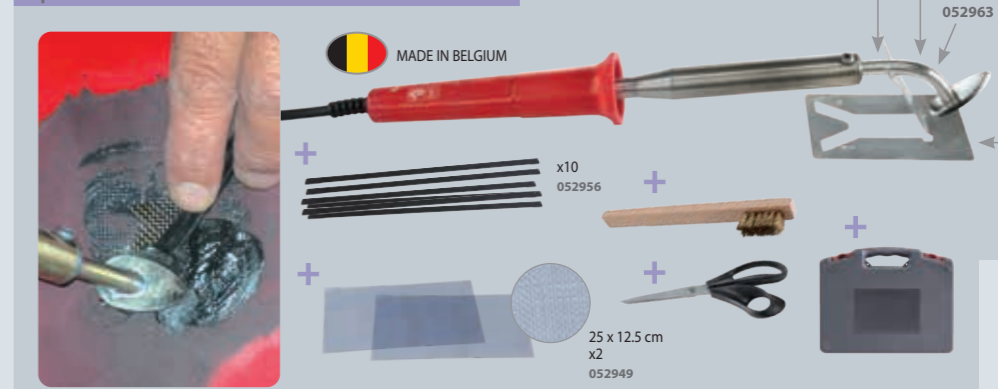

MADE IN BELGIUM

x10
052956

25 x 12.5 cm
x2
052949

057258

052963

WORKSTATION PREMIUM 5 DRAWERS - Servante premium 5 tiroirs

± 64 kg
Capacity 320 kg



4 Keys - 4 Clés

105 cm

56 cm

87 cm

Complete carbody workstation 080119



Workstation only 076143

included



051478 051461 051423 061309 051430 051454 051447 051409 053328 057616 054745 052840 051829 052819

HAND CHISEL FOR CAR BODY

- Burins - Meißel für Karosserie

057586

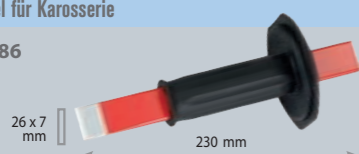

057593



SET OF 4 NYLON CHISELS - Jeu de 4 burins en nylon - 4 Kunststoffmeißel

054745

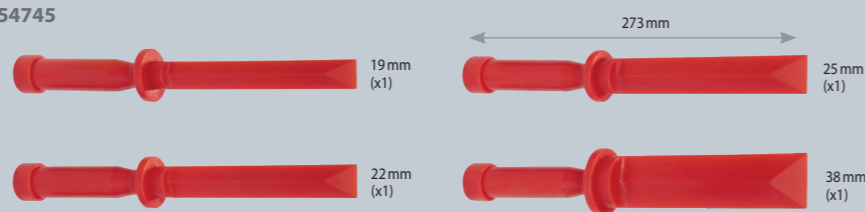

SET OF 3 CHISELS - Lot de 3 burins de séparation éléments collés - 3 Meißel

076754



SET OF 3 SCRAPING KNIVES

- Couteaux racloirs

061439



SET OF 30 TOOLS FOR SCRAPING/SANDING AND PAINT REMOVAL - Outils de dégarnissage et raclage - Polster & Schaber Kit

057616



HAND TOOLS - Ausbeulwerkzeug

• FULL PACK = 061637



+ MEDIUM PACK 051133



PLANISHING HAMMER BLACKTEC®

077270

Rubberised gripping - Manche en caoutchouc



MADE IN GERMANY

Corrosion resistant

ALU HAMMERS - Marteaux alu

020986



PLANISHING KIT FOR CAR BODY (SET OF 3 HAMMERS + 4 DOLLYS) - Kit marteaux et tas - Karosseriehammer & Handfaust Kit



057579

SET OF 3 ALU HAMMERS + 4 ALU DOLLIES - Kit marteaux alu et tas alu - Karosseriehammer & Handfaust Kit



083486

NEW

Alu

FORMING TOOLS - Outils de forme - Formgebungswerzeuge

051195



BODYWORK BUMPING Mallet - Maillet souple caoutchouc - Karosserie-Schlaghammer

083479



NEW

CONTOUR GAUGES - Jauges de profil - Konturenlehre

052840

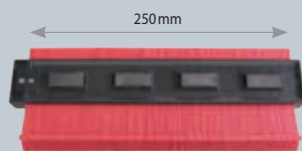

057265

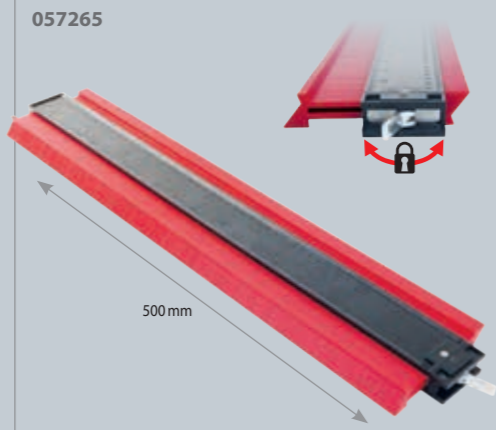
**LIP PLIER** - Pince à lèvres - Falzzange gebogen

079649

**SET OF PLIER + 10 STAPLES**

- Coffret pinces à agrafes

082175

0 - 2.5 mm (x10)
0821822,5 - 5 mm (x 10)
082199**POSITIONING CLAMP** - Pincettes de maintien bord à bord - I-Stoß-Lehre

043190

(x4)

**TEMPORARY-FASTENERS MANUAL MOUNTING** - Serre-tôles(x10)
Ø 2,4 mm
069664(x10)
Ø 4,0 mm
069671(x10)
Ø 4,8 mm
069688(x10)
Ø 6,4 mm
069695**DOOR HINGE STRAIGHTENER** - Redresseur de charnière de porte - Türgelekausrichter

051102

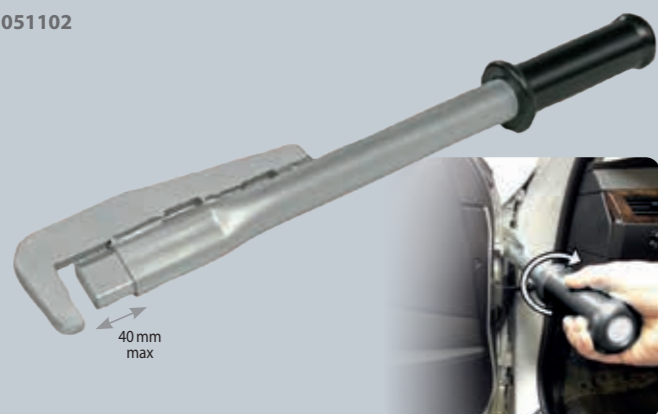
**DOOR ALIGNING TOOL** - Outil d'alignement de portière - Türausrichtungswerkzeug

083424

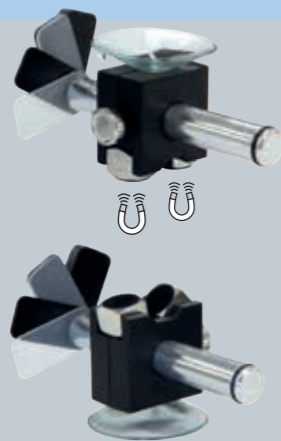
NEW**GAPPING GAUGES** - Jauges de positionnement - Spaltmaßlehrex2
054752**FENDER ROLLER TOOL SET** - Outil de remise en forme passage de roue - Kotflügelrollen-Werkzeugsatz

060791

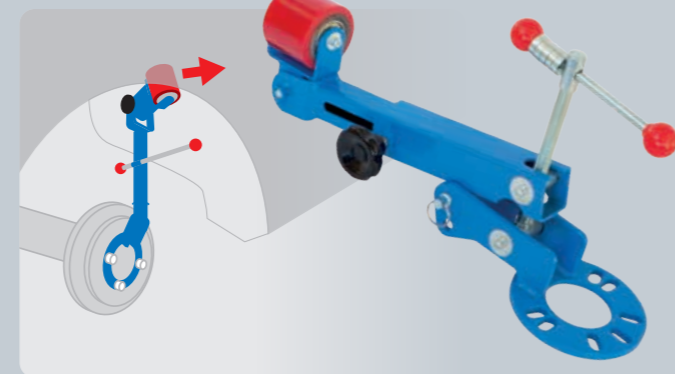
**MULTI-CLIP PLIER** - Pince multi-clip

083813

DURABLE
HIGH-CARBON
STEEL**BURR REMOVER** - Outil d'ébavurage - Gratentferner

079854

**BODY LINE TOOL** - Traceur de ligne carrosserie - Markierhilfe für Kanten

078758

**AXIAL-GRIP PLIERS** - Pincettes axiales

050242

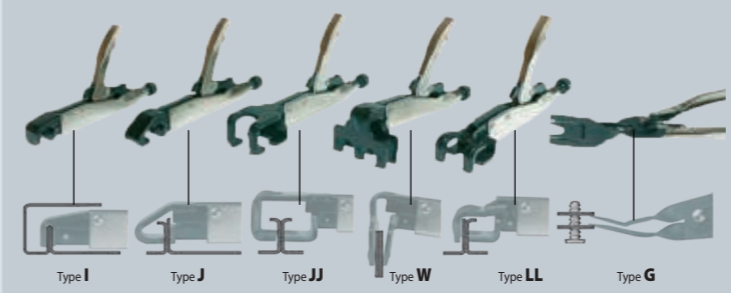
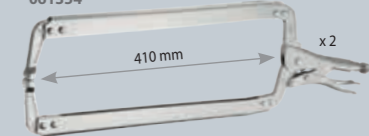
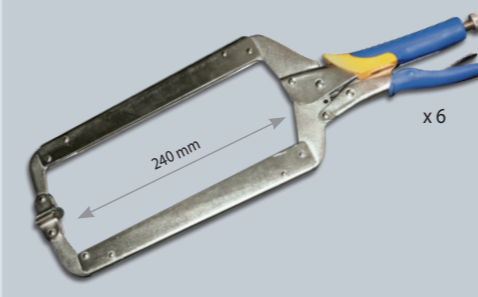
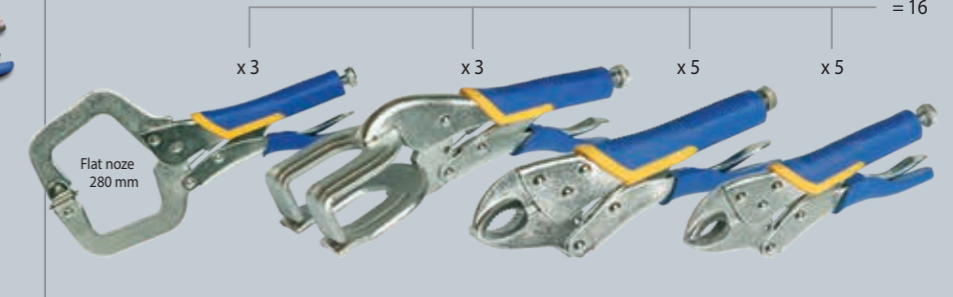
**LOCK-GRIP PLIERS** - Pincettes étai mono serrage280 mm
061378610 mm
061354460 mm
061361Flat noze - 610 mm
061347Flat noze - 460 mm
050112KIT:
050266

MINI DISC SANDER - Mini-meuleuse - Druckluftschleifer

051829

Speed adjustment

Ø 75 mm

Speed rpm	Power W	dB	Air consumption l/min	Air pressure bar	cm	kg
18000	200	83	171	6.2	12	0.7

Included (x1) 052468

LONG HANDLED ANGLE GRINDER - Meuleuse d'angle - Druckluft-Winkelschleifer

057753

Ø 100 mm

± 1.6 mm, x5 057883
± 0.8 mm, x5 058217

Speed rpm	Power W	dB	Air consumption l/min	Air pressure bar	cm	kg
14000	84	113	6.2	37	1.7	

058248

x2 Ø
Ø 50 & 75 mm

Speed rpm	Power W	dB	Air consumption l/min	Air pressure bar	cm	kg
15000	84	91	6.2	10	0.6	

MINI ANGLE GRINDER - Mini-meuleuse à renvoi d'angle - Mini-Druckluftwinkelschleifer geräuschgedämpft

051867

Ø 50 mm

90°

Speed rpm	Power W	dB	Air consumption l/min	Air pressure bar	cm	kg
15000	200	86	85	6.2	18	0.75

(x1) 052772

MINI-FLEXIDISC LAMELLES ZIRCON Ø 50 mm

K 40 (x10) 058255
K 60 (x10) 058262
K 80 (x10) 058279

AIR BELT SANDER - Ponceuse à bande à tête orientable - Druckluft Bandschleifer

060906

520 mm

20 mm

360°

Grain 60 (x 5) 060913
Grain 80 (x 5) 060920
Grain 100 (x 5) 060937
Grain 36 céramique (x 5) 062535

Speed rpm	Air consumption l/min	Air pressure bar	cm	kg
16 000	171	6.3	34	1.2

SAW FOR STRAIGHT CUT AND FILE - Scie coupe tôle droite et lime - Druckluftsäge und Feile

051805

(x5) 052789

included 058750

Speed rpm	Power W	dB	Air consumption l/min	Air pressure bar	cm	kg
5000	—	85	255	6.2	10	0.8

AIR BELT SANDER - Ponceuse à bande à tête orientable - Druckluft Bandschleifer

052819

360°

330 mm

10 mm

Grain 80 (x 10) 052833
Grain 36 céramique (x 20) 062528

Speed rpm	Air consumption l/min	Air pressure bar	cm	kg
16000	171	6.3	26	0.9

MINI ANGLE MILLING MACHINE - Mini-fraiseuse à renvoi d'angle - Mini-Winkelschleifer

051836

90°

Speed rpm	Power W	dB	Air consumption l/min	Air pressure bar	cm	kg
18000	500	81	85	6.2	18	0.7

AUTOMATIC MANDREL DRILL - Perceuse mandrin automatique - Druckluftbohrmaschine m. Schnellspannfutter

051799

Ø 13

Speed rpm	Power W	dB	Air consumption l/min	Air pressure bar	cm	kg
800	300	92	170	6.2	18	0.9

PNEUMATIC SURFACE REMOVER KIT - Coffret décapeuse pneumatique - Druckluftentroster-Box inkl. Zubehör

051775

Roue gomme 115 x 14 mm 051874
Roue à découper 115 x 14 mm 051843
Adaptateur pour brosse 051768

Brosse souple Brins droits 0.5 mm 103 x 23 mm 052598
Brosse dure Brins incurvés 0.7 mm 103 x 23 mm 051812
Brosse souple Brins incurvés 0.5 mm 103 x 23 mm 051850

Speed rpm	Power W	dB	Air consumption l/min	Air pressure bar	cm	kg
4000	500	86	102	6.2	280	1.2

PNEUMATIC FLANGE / PUNCHING TOOL - Pince à soyer et à trouser, pneumatique - Pneumatische Loch- und Absattzange

079892 Ø 8 mm
0.8 > 1,2 mm

052543 Ø 5 mm
0.8 > 1,2 mm

2 in 1

0.8 > 1,2 mm

MINI MILLING MACHINE - Mini Fraiseuse - Mini-Schleifer

063228

Option
Tungsten drill Ø 6 mm 054172

PUNCHING TOOL FOR OVAL HOLES - Outil de poinçonnage oblongs - Langlochkarosserieblechzange

2.2 kg

6 mm 20 mm 052437
8 mm 20 mm 067264

BODY ZIPPER - Sertisseuse pneumatique - Pneumatic Crimper - Druckluftkantenformer

056930

MADE IN HIGH QUALITY POLAND

1) MINI
2) initial W
3) final M x < 2.4mm
4) final D x > 2.4mm

total thickness x=2a+b

Air pressure bar	cm	kg
5	28	2.1

LASER CORD METAL SHEET CUTTER (NIBBLER) - Dépointeuse pour cordon laser ACIER - Trennwerkzeug für Lasernähte

054165

Ø 6 mm

STEEL Included 054172

SPOT REMOVER - Dépointeuse - Druckluft-Schweißpunktbohrer

SPOT DRILL 050464

360°

Ø 8

Included: Tungsten Carbide Ø 8 for BORON/UHSS (x1)

HIGH QUALITY

Spot remover drill - Forets de dépointage - Schweißpunktfräse Tungsten Carbide for BORON/UHSS

Speed rpm	Power W	dB	Air consumption l/min	Air pressure bar	cm	kg
800	400	85	140	6.5	35	2.3

3-edge Ø 8 mm 053069 Ø 9 mm 069763 Ø 10 mm 053076
4-edge Efficiency ++ Durability ++ Ø 8 mm 059849 Ø 9 mm 069770

PACK SPOT DRILL + 140 mm 061460

140 mm 061453

3-edge Ø 8 mm 053069



Youtube

HAND LAMPS - Lampes baladeuses - Handleuchte

PORTABLE HAND LAMP 400 L 400 lumens

COB LED
Li-ion
Charging time: 8h
operating time
High position: 2.5 h
Low position: 5 h
Top light (1 W): 6 h

↓ 7 x 4 x 23 cm / 0.3 kg
⊗ 14 x 7 x 24 cm / 0.5 kg

059153



PRO PORTABLE LAMP 600 L 250-600 lumens

COB LED, 80 CRI
3.7 V - 2200 mAh Li-ion
micro USB charging (3.5 h)
operating time:
High position: 1.5 h,
Mid position: 4.5 h,
Top light (100 lumens): 10 h

IP 54
↓ 3 x 6 x 19 cm / 0.3 kg
⊗ 9 x 13 x 24 cm / 0.6 kg

060883



INSPECTION LAMPS - Lampes d'inspection - Inspektionlampen

INSPECTION HEADTORCH 280 L 100-280 lumens

3 W COB LED, 80 CRI+, 6500 K
3.7 V - 1500 mAh Li-po
micro USB charging
mains charger not incl.
operating time
High position: 2 h
Low position: 6 h
IP 65

↓ 8 x 5 x 4 cm / 0.1 kg
⊗ 5 x 11 x 18 cm / 0.2 kg

060845



360° PORTABLE WORKSPACE LAMP 1000 L 60-1000 lumens

>80 CRI SMD LED
6500 K
3.7 V - 5200 mAh Li-ion
USB charging (4.5h)
USB power supply
operating time 2 > 27 h

IP 54
↓ 26 x 7 x 7 cm / 0.5 kg
⊗ 8 x 8 x 35 cm / 0.7 kg

059764



MINI INSPECTION LAMP 200 L 120-200 lumens

COB LED, 80 CRI, 6500 K
3.7 V - 700 mAh Li-ion
micro USB charging (2.5 h)
mains charger not included
operating time
High position: 1.5 h
Low position: 4 h
Top light: 3.5 h
IP 20

↓ 18 x 3 x 3 cm / 0.1 kg
⊗ 18 x 5 x 3 cm / 0.2 kg

060852



MINI INSPECTION LAMP 350 L 0-350 lumens

COB LED
3.7 V - 1100 mAh Li-ion
USB charging (3 h)

operating time
3 > 6.5 h

IP 20

075894

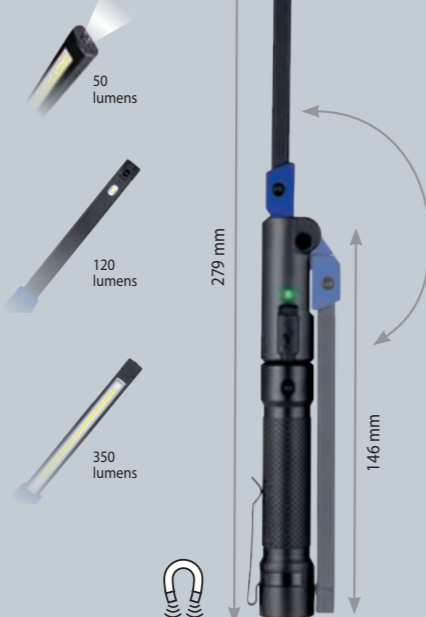

PRO INSPECTION LAMP 800 L 120-800 lumens

COB LED
3.7 V - 2600 mAh Li-ion
USB charging (4 h)

operating time
2.5 > 9 h

IP 54

075900

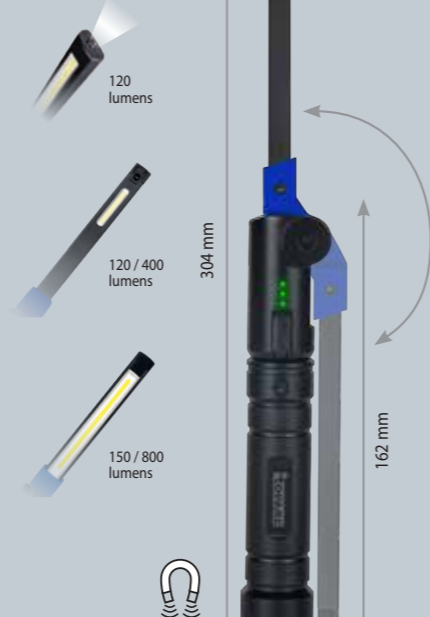

LED WORKLIGHTS WITH TRIPOD - Projecteurs led sur trépied - LED-Arbeitsleuchte mit Standfuß

TRIPOD LAMP 1800 L 1800 lumens

3x 55 COB LED
total 165 LED

1.8 m power cord

059146

⊗ 95 x 15 x 14 cm / 3.2 kg



TRIPOD LAMP 3000 L 3000 lumens

35 W COB LED

2 m power cord

IP 44

059979

↓ 100 x 20 x 9 cm / 3.6 kg
⊗ 103 x 22 x 10 cm / 4.1 kg



TRIPOD LAMP 4000 L 4000 lumens

3x 20 COB LED,
total 60 LED

3 m power cord

059986

↓ 21 x 15 x 114 cm / 5.7 kg
⊗ 22 x 116 x 117 cm / 6.4 kg



UNDER BONNET LAMPS - Lampes sous capot - Leuchte für Motorhaube

UNDER BONNET HAND LAMP 600 L 500-1000 lumens

120 COB LED

3.7 V - 4000 mAh Li-ion
charging time: 10/12 h

operating time
High position: 4 h
Low position: 8 h

↓ 22 x 11 x 68 cm / 1.8 kg
⊗ 24 x 12 x 70 cm / 2.3 kg

059962

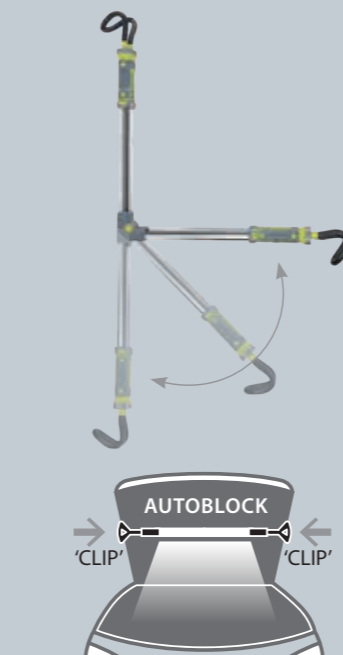

UNDER BONNET LAMP AND TRIPOD 800 L 250-800 lumens

120 COB LED

3.7 V - 4000 mAh Li-ion
charging time: 10/12 h

operating time
High position: 3 h
Low position: 6 h

↓ 60 x 10 x 7 cm / 1.2 kg
⊗ 61 x 15 x 12 cm / 2 kg

058002

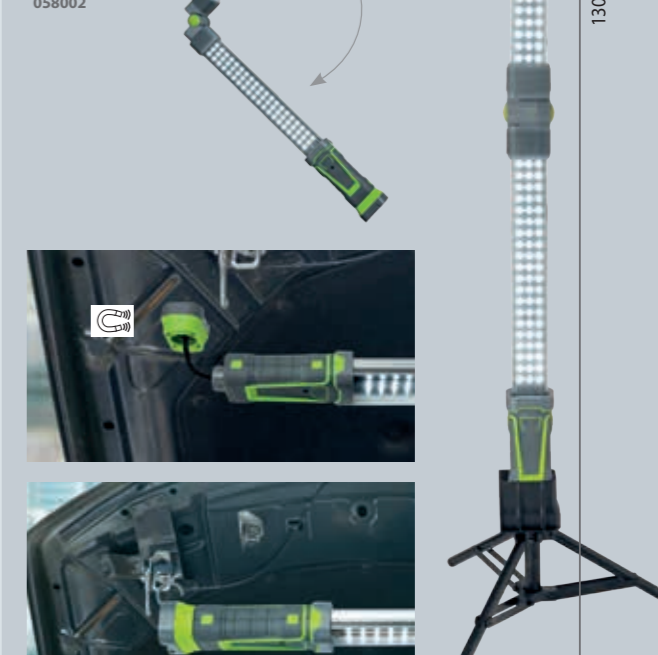

DETAILING & COLOUR MATCH - Contrôle des couleurs - Fabnpassung & Aufbereitung

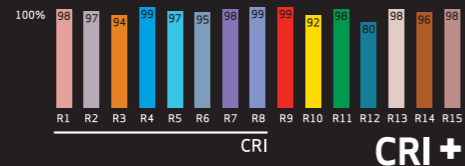

4500 K

400 lumens

SUNCOLOR 1
COB LED, CRI > 95, 1100 lux
3.7 V - 2600 mAh Li-ion
USB charging
operating time : 3 h
↓ 6 x 3 x 19 cm / 0.6 kg
⊗ 22 x 14 x 10 cm / 0.7 kg
IP 65



3 COLORS

2700 - 4500 - 6500 K

350-420-450 lumens

SUNCOLOR 3
COB LED, 96 CRI+
3.7 V - 2600 mAh Li-ion
micro USB charging (4 h)
operating time : 2.5/4 h
IP 65
↓ 4 x 6 x 9 cm / 0.3 kg
⊗ 9 x 13 x 24 cm / 0.6 kg



5 COLORS

2700 - 3500 - 4500 - 5500 - 6500 K

500-1000-2000 lumens

SUNCOLOR 5
COB LED, 96 CRI+
11.1 V - 4400 mAh Li-ion
charger 110/240 V, 5 m cable, 15 V, 1.5 A
operating time : 3.5 h
operating time
High position : 2 h, Mid : 4 h, Low : 8 h
IP 65
↓ 7 x 23 x 20 cm / 1.2 kg
⊗ 9 x 25 x 24 cm / 1.9 kg



5 COLORS

2500-3500-4500-5500-6500 K

50-200-500 lumens

SUNMATCH 4
COB LED, 96 CRI+, 700-1400 lux
3.7 V - 2600 mAh Li-ion, USB charging
operating time :
High position : 2 h, Low position : 4 h
IP 65
↓ 4 x 6 x 19 cm / 0.3 kg
⊗ 8 x 9 x 21 cm / 0.5 kg



UV CURING - SÉCHAGE UV

UV LED λ 395-400 nm

Irradiance 6-15 mW/cm²

NOVA-UV 5
3.7 V - 5400 mAh Li-ion
USB charger, 1 m cable, 5 V, 2 A
charging time : 3.5 h
curing area : Ø 20 cm
operating time 1.5 h
IP 67
↓ 7 x 17 x 16 cm / 0.9 kg
⊗ 7 x 17 x 18 cm / 1 kg

061620



FILM COATING THICKNESS GAUGE

- Détecteur épaisseur de peinture

059856

Measurement range : 0 - 1.80mm
Resolution : 0.01 mm / 1 mm
Measurement error : +/- 0.03 mm
Power Supply : 2x 1.5V AAA batteries (included)
Overall dimensions : 62 x 30.5 x 105 mm



4 MAGNETIC PANEL EDGE PROTECTIONS

- 4 protections magnétiques de ponçage pour bord de panneau

082793

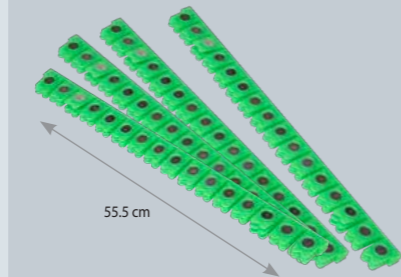

ELECTRIC SANDER & POLISHER

- Ponçeuse /polisseuse électrique - Elektro-Polier-Schleifer

057999

Orbital 5.0 mm
↓ 27 x 15 x 10 cm / 1.5 kg
⊗ 37 x 18 x 12 cm / 1.9 kg

Speed : 4000, 7000, 9000 10000 rpm
AC-in 220V - 230V / 50 - 60Hz

Light weight
& Compact

((No vibration))



058293

Power supply : 230V / 50Hz
Power : 1400W (max 2000W)
Max. vacuum : 170 mbar
Air flow : 2700 l/min
Drum capacity : 30 L
Drum material : stainless steel

↓ 33 x 33 x 63 cm / 4.9 kg
⊗ 38 x 38 x 67 cm / 7.8 kg

Manual or automatic



4m
Input Ø 32 mm
Mains cable length 4.5m

GYS DUST EXTRACTOR - Pneumatic dust vacuum cleaner for sander

INNOVATIVE SUCTION SYSTEM

Depression **1150 mm H2O**
Air flow **600 l/min**
Air consumption **340 l/min**



Adjustable sander pressure - Pression ponçeuse ajustable
5 bar max

↓ 49 x 48 x 88 cm / 21.5 kg
⊗ 81 x 40 x 49 cm / 24.1 kg



EN 60335-2-69 : 2012

- ✓ **ROBUST**
- ✓ **QUICK & SAFE**
- ✓ **LOW AIR CONSUMPTION**
(5 bar)
- ✓ **NO ELECTRIC MOTOR**
- ✓ **ENERGY SAVING**

Sanding discs box*
- Rangement pour disques de ponçage*
* discs box not included - disques de ponçage non inclus

Grande maniabilité et stabilité
- High maneuverability and stability

EASY ACCESS

Maintenance free
- Aucune maintenance

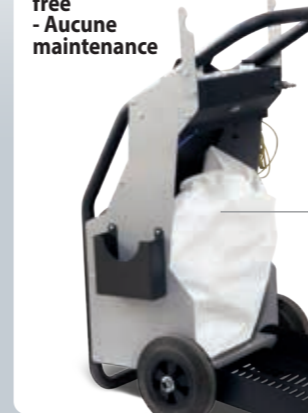

Consumables

Sac à poussières - Filter bag
Capacity 5 kg
Included x1
x 5
058880



Pneumatic Sander
- Ponçeuse pneumatique
MIRKA PROS 650CV
Ø 150 mm
071346

2 MODELS

GYS DUST EXTRACTOR

MANUAL

Manual start
- Démarrage manuel

071353



GYS DUST SELF EXTRACTOR

AUTOMATIC

Automatic start
- Démarrage automatique

077058



ERGONOMIC PRO SUPPORT FOR PAINTING ELEMENTS - Support Pro ergonomique pour peinture d'éléments
- Ergonomische Pro-Unterstützung für Malelemente

082656

NEW
05/2024

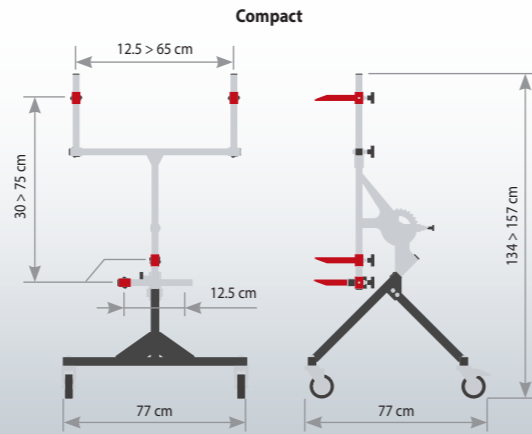
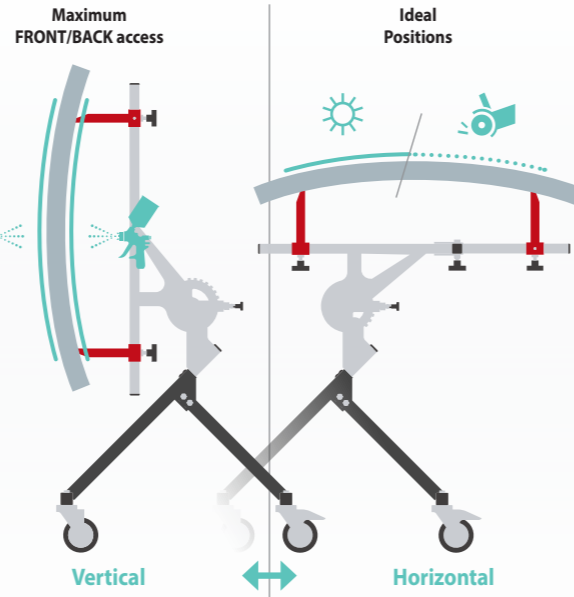
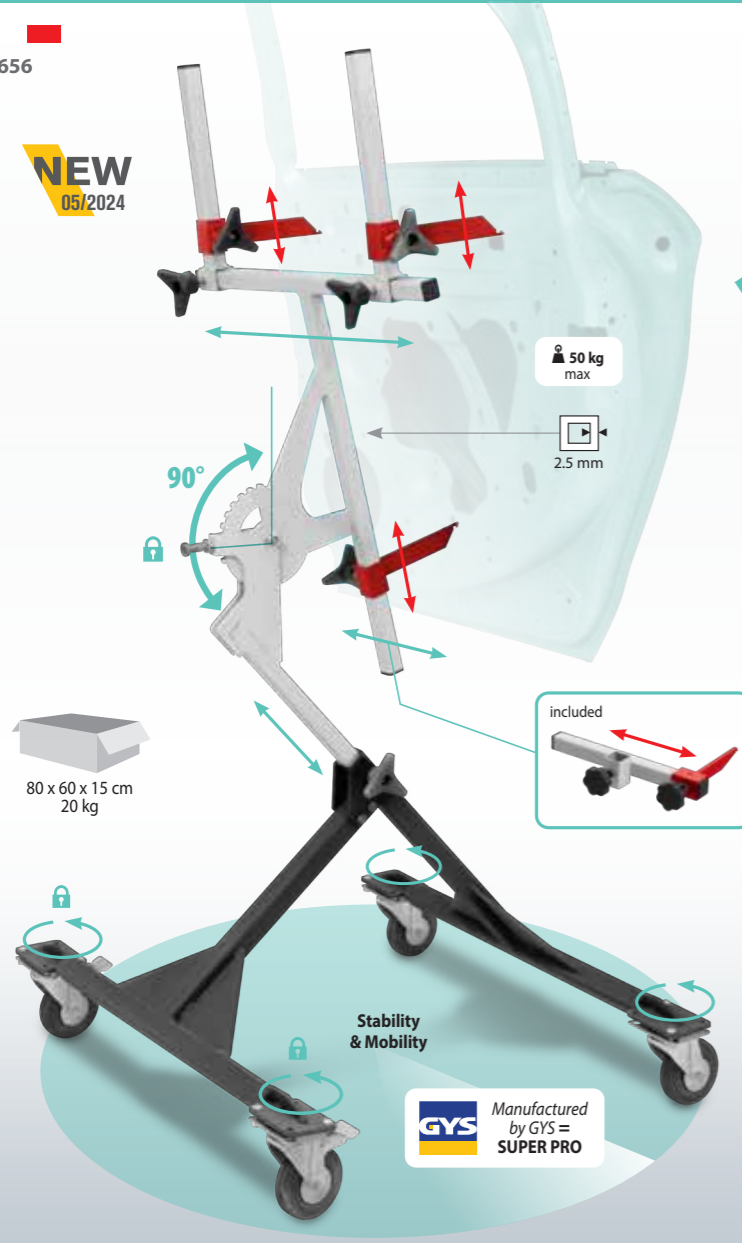

Stability & Mobility
GYS Manufactured by GYS = SUPER PRO

FRAMES SUPPORT - Tréteaux - Klappbücke

<p>040601 ↓ 105 x 33 x 9 cm / 6.3 kg ⊗ 107 x 35 x 10 cm / 6.7 kg</p> <p>Adjustable catenary - Chainette réglable</p>	<p>040250 ↓ 100 x 105 cm - 7.1 kg ⊗ 104 x 10 x 32 cm / 7.5 kg</p> <p>Protecting foam - Mousse de protection</p>	<p>083875 14.4 kg ⊗ 108 x 9 x 47 cm / 16.5 kg</p> <p>Non-slip base - Antidérapants</p>
<p>040311 ↓ 106 x 31 x 6 cm / 6.6 kg ⊗ 106 x 31 x 11 cm / 9.7 kg</p> <p>Suction pad for glazing - 4 ventouses Dépose vitrages - Gummiteiler zur Fixierung von Glasscheiben</p>	<p>040304 ↓ 105 x 109 cm / 7.2 kg ⊗ 107 x 32 x 10 cm / 7.8 kg</p> <p>Light and easy to handle Ideal for horizontal works - Léger et très maniable Spécial travaux à l'horizontal - Speziell geeignet für Arbeiten in horizontaler Position</p>	

ROTARY ELEMENT SUPPORT - Support pare-chocs - Lackierstander für Stoßstange, einstellbar

052376
↓ 50 x 70 x 10 cm / 7.3 kg
⊗ 60 x 77 x 12 cm / 8.3 kg

Adapted to wing mirror covers - Adapté aux coques de rétroviseurs
- Geeignet für Außenspiegel

TELESCOPIC FRAMES SUPPORT - Tréteaux télescopiques - Teleskopbücke

<p>083882 29 kg</p> <p>NEW 08/2024</p> <p>30 > 100 cm</p> <p>85 > 120 cm</p> <p>81 cm</p> <p>⊗ 81 x 74 x 14 cm / 30.7 kg</p>	<p>070677 16.5 kg</p> <p>MADE IN HIGH QUALITY POLAND</p> <p>15 > 125 cm</p> <p>88 > 128 cm</p> <p>20 x 20 mm</p> <p>3 mm</p> <p>87 cm</p>
---	---

ROTARY ELEMENT SUPPORT - Support élément rotatif - Lackierstander für Stoßstange, einstellbar

1.5 mm

360°

2 mm

052611
200 x 101 cm - 19 kg
⊗ 112 x 35 x 13 cm / 23 kg
Made in China

PRO
056725
200 x 105 x 81 cm - 21.5 kg
⊗ 120 x 26 x 18 cm / 22 kg

MADE IN HIGH QUALITY POLAND

WHEELS PAINTING SUPPORT - Support de peinture pour 2 jantes - Lackträger für 2 Felgen

082168
⊗ 83 x 45 x 35 cm / 25 kg

15" → 22"

109 cm

95

67

MASKING MACHINE - Chariot de marouflage - Abdeckpapier-Ständer

083905
132 x 95 x 91 cm / 35 kg
⊗ 109 x 92 x 27.5 cm / 37 kg

NEW

x 4 (not included)

Paper roll - Rouleaux de papier - Papierständer
30, 60, 100, 100 cm

PREMIUM MASKING MACHINE - Chariot de luxe marouflage - Abdeckpapier-Ständer

057333
150 x 133 x 62 cm / 31 kg
⊗ 152 x 30 x 18 cm / 31.5 kg

x 5 (not included)

Paper roll - Rouleaux de papier - Papierständer
30 > 120 cm

MASKING MACHINE - Chariot de marouflage - Abdeckpapier-Ständer

056954
150 x 62 x 110 cm / 11 kg
⊗ 154 x 30 x 19 cm / 12 kg

MADE IN HIGH QUALITY POLAND

OPTION
Ø 40 mm x 6
058897

x 3 (not included)

Paper roll - Rouleaux de papier - Papierständer
30, 60, 90 cm

STORAGE TROLLEY - Chariot de stockage
- Lagerrollwagen

059825

106 x 104 x 215 cm - 32.5 kg
112 x 31.5 x 21.5 cm
+ 12 x 9.5 x 194.5 cm

STORAGE TROLLEY - Chariot de stockage
- Lagerrollwagen

059832

↓ 50 x 150 cm / 11.3 kg
⊗ 155 x 18 x 12 cm / 13.8 kg

STORAGE TROLLEY - Chariot de stockage
- Lagerrollwagen

040243

71 x 90 x 197 cm / 41 kg
⊗ 2 : 90 x 6 x 147 cm + 97 x 74 x 24 cm

ROUND STOOL WITH TOOL STORAGE
- Tabouret - Werkstatt-Rollhocker

057555
38 x 38 x 44 cm - 5.2 kg
⊗ 41 x 19 x 41 cm / 5.6 kg

max : 50 cm
min : 38 cm

6 cm

ROUND STOOL WITH STORAGE
- Tabouret d'atelier 3 tiroirs

079878
47 x 35 x 43 cm
⊗ 38.5 x 37 x 38.5 cm - 13 kg

WORKSTATION PREMIUM 5 DRAWERS
- Servante premium 5 tiroirs

076143
⊗ 64 kg
Capacity 320 kg

4 Keys - 4 Clés

32 x 45 x 6 cm
65 x 48 x 12 cm
75 x 47 x 9 cm
65 x 45 x 12 cm
32 x 45 x 12 cm

105 cm

56 cm 87 cm

UNIVERSAL SUPPORT - Chariot pour éléments de carrosserie
- Universelle Ständer

083868
56 kg
⊗ 102 x 72 x 27 cm / 59 kg

NEW

+ 60 cm

85 cm 100 cm 210 cm

FOLDING STEP STOOL - Marche pied (Aluminium)
- Arbeitspodest klappbar

080041
7.3 kg
⊗ 100 x 39.5 x 19 cm / 8.1 kg

ALU

150 kg max

850 mm 490 mm 1180 mm 300 mm

MOBILE RACK FOR CAR BODY REPAIR
- Rack mobile pour éléments de carrosserie

082472
⊗ 128 x 30 x 15 cm / 20 kg
↓ 18.8 kg

NEW

150 kg max

635 mm 1200 mm 700 mm

FOLDING STEP STOOL - Marche pied (Aluminium)
- Arbeitspodest klappbar

057562
7.9 kg
⊗ 102 x 39 x 19 cm / 8.5 kg

ALU

150 kg max

960 mm 475 mm 385 mm

FLAP LOCK - Tiges de blocage

056732

30 > 115 cm

FOLDING STEP STOOL - Marche pied (Aluminium)
- Arbeitspodest klappbar

058552
↓ 113 x 41 x 16 cm / 16 kg
⊗ 117 x 42 x 17 cm / 17 kg

ALU

150 kg max

1090 > 1750 mm 520 > 900 mm 300 mm

MECHANICS CREEPER WITH TILTING HEADREST
- Chariot de visite - Werkstatt-Rollliege

057548
102 x 43 x 11 cm / 5.3 kg
⊗ 104 x 45 x 13 cm / 6 kg

MOBILE WORKSTATION
- Table de travail mobile

079465
⊗ 120 x 82 x 18 cm / 40.3 kg

100 kg max

1170 mm 390 mm 1030 mm 750 mm

Ø 290 mm

2 IN 1 MECHANICS CREEPER
- Chariot de visite 2 en 1 - Werkstatt-Rollliege

079861
102 x 40 x 14 cm
⊗ 40 x 13 x 63 cm - 7.6 kg

WORKSTATION 3 SHELVES
- Servante 3 plateaux

068056
⊗ 77 x 53 x 21 cm / 18.2 kg

65 kg max

65 kg max

65 kg max

835 mm 300 mm 800 mm

1T MOBILE LIFTING TABLE WITH HYDROPNEUMATIC PUMP - Table élévatrice mobile 1 tonne avec pompe hydropneumatique
- Mobilier 1-Tonnen-Hubtisch mit hydropneumatischer Pumpe

083912
Weight : 385 kg



NEW

max : 180 cm

min : 570 cm

max : 148 cm
min : 130 cm

80 cm

105 cm

130 cm

Ø 20 cm

Reserved holes pattern
- Quadrillage de trous taraudés
100 x 100 mm M10

1 t max

Hydropneumatic pump
- Pompe hydropneumatique

110 s

30 s

6-8 bar

1.2T LIFTING TABLE FOR ELECTRIC VEHICLE BATTERIES - Table de levage 1.2T pour batteries de véhicule électrique
- 1,2T Hubtisch für Elektrofahrzeugbatterien

083929
Weight : 760 kg

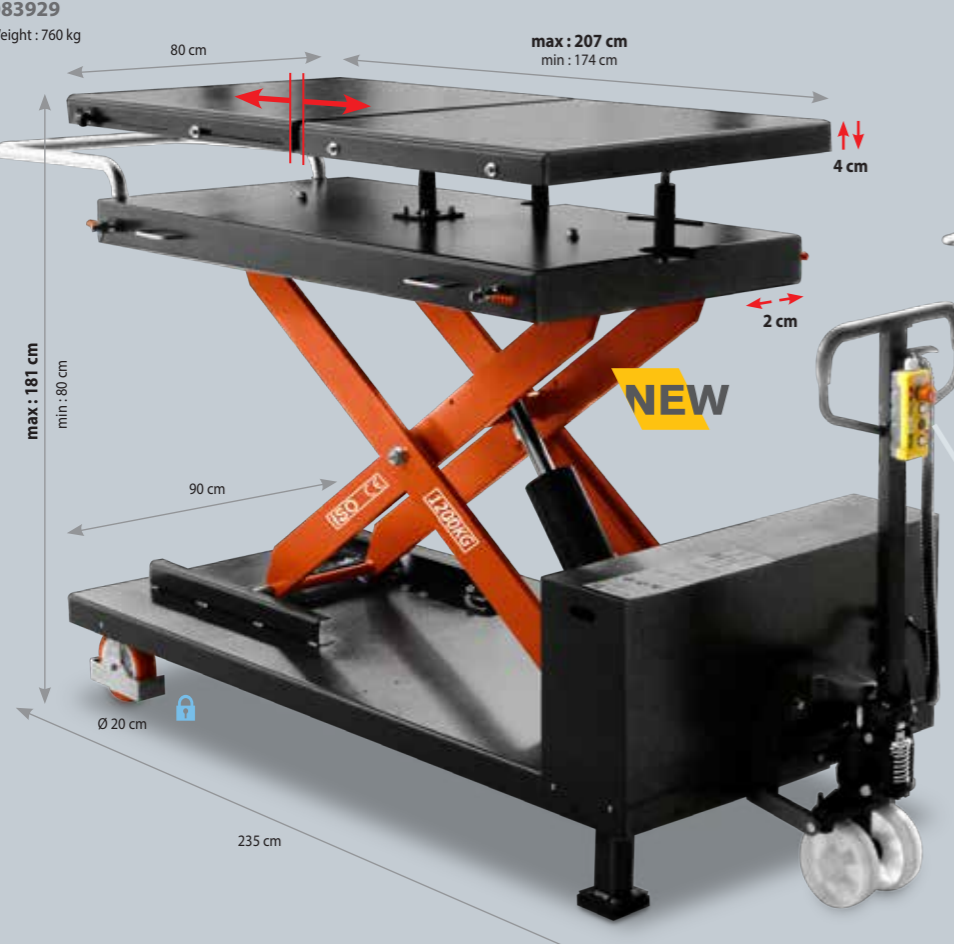

NEW

max : 207 cm
min : 174 cm

80 cm

4 cm

2 cm

90 cm

max : 181 cm
min : 80 cm

Ø 20 cm

235 cm

Reserved holes pattern
- Quadrillage de trous taraudés
100 x 100 mm M10

1.2 t max

230 V ~1 phase
50 Hz

FAST : 45 s

PRECISE : 170 s

40 s

EQUIPMENT FOR OPERATIONS ON ELECTRIC AND HYBRID VEHICLES - Équipements pour opérations sur véhicules électriques & hybrides -
Ausrüstung für den Betrieb von Elektro- und Hybridfahrzeugen

FACE SHIELD WITH HEADBAND
- ÉCRAN FACIAL AVEC SERRE-TÊTE
068018



INSULATING GLOVES (T10)
- GANTS ISOLANTS (T10)
068025



25 pieces insulated tools 1000V - Coffret de 25 outils isolés 1000V
- Box mit 25 isolierten Werkzeugen 1000V
066489

7/8/10/12/14/15/17/19/22 mm sockets - Douilles 7/8/10/12/14/15/17/19/22 mm	x 9
175 mm universal pliers in chrome vanadium - Pince universelle de 175 mm en chrome vanadium	x 1
Cutting pliers 150 mm in chrome vanadium - Pince coupante 150 mm en chrome vanadium	x 1
3/8" ratchet - Cluqlet en 3/8"	x 1
Extension 100 mm - Rallonge 100 mm	x 1
T-handle - Poignée en T	x 1
Open ended wrenches 7/8/10/12/14/17 mm - Clés plates à fourches 7/8/10/12/14/17 mm	x 6
Cable knife - Couteau pour câble	x 1
Philips PhH1x100/PhH2x100 mm screwdriver - Tournevis Phillips PhH1x100/PhH2x100 mm	x 2
Flat screwdriver 5.5x125 / 4x100 mm - Tournevis plats 5.5x125/4x100 mm	x 2

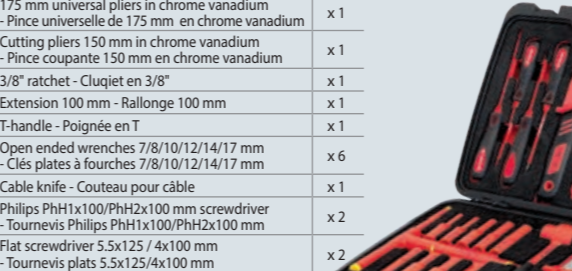

Kit for marking the area of intervention
- Kit pour le balisage de la zone d'intervention
- Kennzeichnungsset für Hochvolt-Bereiche
064409

Red and white warning pole - Balise de signalisation rouge et blanche	x 4
Red and white bounding line - Chaîne de délimitation rouge et blanche	x 1
Sign board "Danger, working area EHV" - Pancarte de signalisation "Danger, zone de travail VEH"	x 2



TROUSERS - Pantalon - Hose



98% cotton, 2% antistatic

EN ISO 11611 Class 2-A1 & A2

EN ISO 11612 A1+A2-B1-C1-E3-F1

IEC 61482-2 Class 1-4kA

EN 1149-5

EN 14404 +A1 Type 2

S (40/42) 046368

M (44/46) 046375

L (48/50) 046382

XL (52/54) 046399

XXL (56/58) 046412

JACKET - Veste - Jacke



98% cotton, 2% antistatic

IEC 61482-2 Class 1-4kA

EN ISO 11612 A1+A2-B1-C1-E3-F1

EN 14404 +A1 Type 2

EN ISO 11611 Class 2-A1 & A2

EN 1149-5

S (40/42) 046313

M (44/46) 046320

L (48/50) 046337

XL (52/54) 046344

XXL (56/58) 046351

HEAT COVER - Couverture anti-chaueur - Hitzeschutzdecke - Manta anti-calor - Protecção anti-aquecimento



PROTEC 550
 550°C/1000°F - Class M0
 2 m x 2 m - 580 g/m²
 050495

PROTEC 1200
 1200°C/2200°F - Class M0
 1.75 m x 1.5 m - 1200 g/m²
 050204

PROTEC 1300
 1300°C/2400°F - Class M0
 XL : 2 m x 1.8 m - 620 g/m²
 053595

PROTEC 1300L
 1300°C/2400°F
 XL : 2 m x 1.8 m - 427 g/m²
 060500

SET OF 2 MAGNETS

- Jeu de 2 aimants
- Schweißmagnet



(x2)
052291

MAGNETIC COVER - Couverture magnétique - Magnetschutzdecke



1.06 m x 0.6 m
061446

RIDEAU DE SOUDAGE - Welding curtain and frame - Schweißerschutzwand

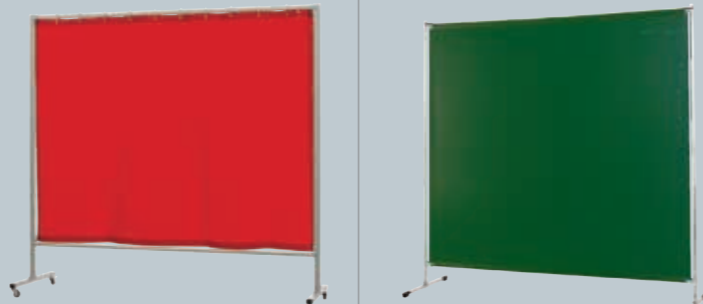

OPTI 215.0
Orange CE - 2 x 2.15 m
EN 25980 - 2015/01
060470

OPTI 200G
Green T9 - 2 x 2 m
EN 25980 - 2015/01
060463

RESPIRATORY MASKS - Masques respiratoires - Atemschutzmaske - Máscaras respiratorias



FFP3 - EN 140 / EN 143 / EN 166
(x1) Size M/L
037021

FFP3 - EN 140 / EN 143
(x1) Size M/L
037014

Étui / Case
037045

FFP3 - EN 143 : 2000 P3
Anti poussières
/ Anti odeurs
037038

PROTECTION GOGGLES

- Lunettes de protection - Schutzbrillen



EN 166

Shade/RO 042810

Shade/RO 042827

Shade/RS 042841

Shade/RO 047778

Shade/RO 047792

Shade/RO 042865

Shade/RO 047839

GLOVES - Gants - Handschuhe - Guantes



Anti-cut - Anti coupure T9 045897

EN388 4342

✓ touch screen friendly - écran tactile - High resistance anti-cut - Anti coupure haute résistance EN 420 EN 388:4121 T9: 045910 T10: 045927

High dexterity anti-cut - Anti coupure haute dextérité EN 420 EN 388:1121 T9: 045903 T10: 045934

T10 064188

EN420 2003

EN388 2003

Ultra Flexible

EN388 2122

EN 407 322X2X EN12477 Class: A1

Gants PRO TIG T10 045194

EN388 4244

EN 407 424X4X EN12477 Class: A1

Heavy Duty T10 (MMA - MIG - Plasma) 045101

EN388 4244

EN 407 424X4X EN12477 Class: A1

Reinforced welding gloves - Gants de soudage renforcés T10 045873

EN388 2011XX

Gants PRO TIG EXTRA T10 045323

EN 407 41313X EN12477-B EN 420

PRO 045217

MULTI-USE LEATHER APRON

- Tablier cuir multi-usage
- Delantal de cuero multi-uso
- Mehrzweck-Lederschürze



PRO 045217



★★★★★ **THEY TRUST US** ★★★★★

ILS NOUS FONT CONFIANCE

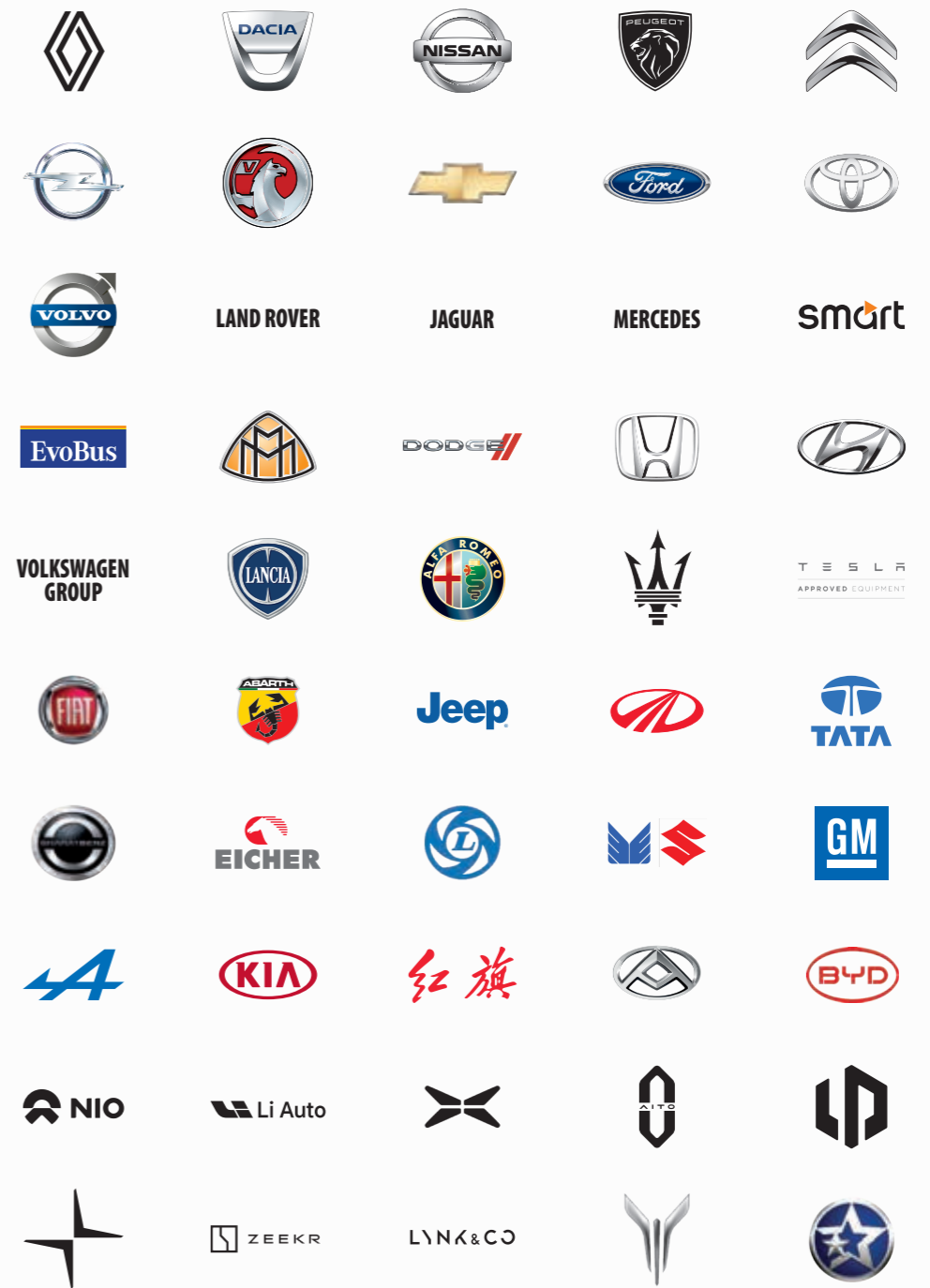



INVEST IN THE FUTURE



French manufacturer
since 1964

2
0
2
4
B

Collision Repair

Solutions Réparation Carrosserie
Karosseriereparatur
Attrezzature Riparazione Carrozzerie
Reparación de Carrocería



LinkedIn
 Youtube
 WeChat
 Facebook
 Instagram

www.gys.fr



GYS FRANCE

HEADQUARTERS

1 rue de la Croix des Landes
CS 54159
53941 Saint-Berthevin - Cedex
Laval - France
Tel +33 2 43 01 23 60
E-mail service.client@gys.fr



ZI, 134 bd des Loges
53941 Saint-Berthevin
Laval - France

LOGISTIC CENTER

2 Rue Jean Dausset
53810 Changé - France
Tel +33 2 43 01 54 33



GYS GERMANY

Professor-Wieler
Straße 11
52070 Aachen
Deutschland

Tel +49 241/189-23-710
Fax +49 241/189-23-719
E-mail aachen@gys.fr



GYS UK

Unit 3 - Great Central Way
Rugby - Warwickshire
CV21 3XH
United Kingdom

Tel +44 1926 338 609
Fax +44 1926 429 764
E-mail uk@gys.fr



GYS ITALIA

Via Porta Est, 7
30020 Marcon - VE
Italia

Tel +39 041 53 21 565
E-mail italia@gys.fr



GYS IBÉRICA

Avenida Pirineos 31
Nave 9
San Sebastian de los Reyes
28703 Madrid
España

Tel +34 917 409 790
E-mail iberica@gys.fr



GYS CHINA

Lot N°15
6666 bd Songze
201706 Qingpu
Shanghai
China

Tel +86 6221 4461
Fax +86 5226 0067
www.gys-china.com.cn
E-mail
contact@gys-china.com.cn

MARKETING

Display stand
- Podium de
présentation
- Podest

PODIUM 1
A : 45 cm
B : 50 cm
C : 50 cm
063204

PODIUM 2
A : 80 cm
B : 50 cm
C : 50 cm
063211

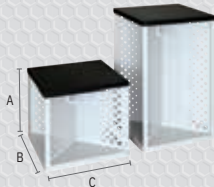

Flag -
Oriflamme
3 x 0,50 m
098015



Barnum
3 x 3 m
098022



Open barnum
2 x 2 m
098039

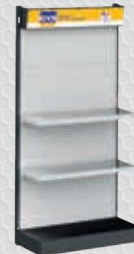

Retail display
space with 2
shelves
- Linéaire de vente
avec 2 étagères
- Lochwandregal
mit 2 Böden
(machines not
included)
060784



Distributed by